

@ fegol®



PRODUCTS CATALOGUE

CATÁLOGO DE PRODUCTOS

CATALOGUE DES PRODUITS

CATÁLOGO DE PRODUCTOS

PRODUCTS CATALOGUE

CATÁLOGO DE PRODUTOS
CATALOGUE DES PRODUITS
CATÁLOGO DE PRODUCTOS

WRITE _ ESCRITA
ÉCRITURE _ ESCRIBIR

04

EXPLORE _ EXPLORAR
EXPLORER _ EXPLORE

20

LEARNING _ APRENDER
APPRENDRE _ APRENDER

40

ARCHIVE _ ARQUIVO
ARCHIVO _ ARCHIVES

54

ORGANIZATION _ ORGANIZAÇÃO
ORGANIZACIÓN _ ORGANISATION

72

ANNOTATE _ ANOTAR
ANNOTER _ ANOTAR

88

LOGISTICS _ LOGÍSTICA
LOGÍSTICA _ LA LOGISTIQUE

102

PRESENTATION _ APRESENTAÇÃO
PRÉSENTATION _ PRESENTACIÓN

110

WRITE

ESCRITA

ÉCRITURE

ESCRIBIR



Funny ballpoint pen

Ultra smooth ink pen for faster and effortless writing. Quick drying, available in 8 bright colors, which will revolutionize your day-to-day. Ballpoint pen with round and clear barrel, a non-slip metal tip with translucent body and cap.

Esferográfica Funny

Esferográfica de tinta ultra suave, para uma escrita mais rápida. A sua fluidez torna a escrita sem esforço. De secagem rápida, disponível em 8 cores de escrita, que revolucionará o seu dia-a-dia. Na forma redonda, tampa com clip em cores translúcidas.



Stylo bille Funny

Stylo bille à encre ultra-doux pour une écriture plus rapide. Sa fluidité rend l'écriture sans effort. Séchage rapide, disponible en écriture 8 couleurs, qui révolutionnera votre quotidien. En forme ronde, couvrir avec un clip en couleurs translucides.



Bolígrafo Funny

Esferográfica de tinta ultra suave, para una escritura más rápida. Su fluidez hace la escritura sin esfuerzo. De secado rápido, disponible en 8 colores de escritura, que revolucionará su día a día. En forma redonda, tapa con clip en colores translúcidos.

ITEM	REF.	Color	Ballpoint	Retractable	Ballpoint	Retractable
001004080801	808-01	Blue	✓	✓	12	144
001004080802	808-02	Black	✓	✓	12	144
001004080899	808-99	9x 9x 5x 5x 5x 5x 5x 5x	✓	✓	48	1

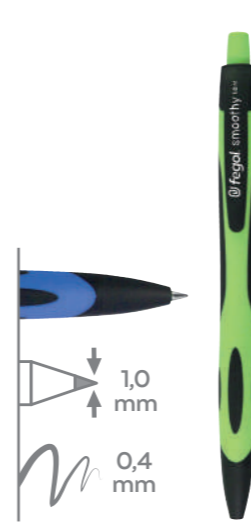

Smoothy ballpoint pen

Ballpoint blue pen with ultra smooth ink for faster, smoother writing. Body in soft touch plastic coating. Allows consistent ink flow from start to finish. Premium Quality.



Esferográfica Smoothy

Esferográfica de cor azul, com revestimento em plástico "soft touch" de tinta ultra suave, para uma escrita mais rápida e suave. Permite um fluxo de tinta consistente do seu início ao fim. De Qualidade Premium.

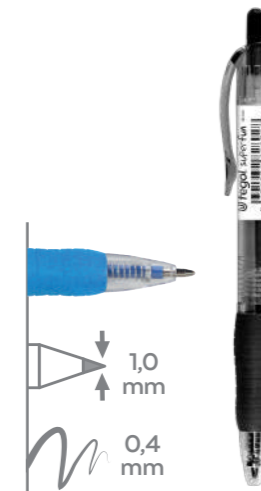

Superfun ballpoint pen

Retractable ballpoint pen with transparent body and clip, with ergonomic rubber grip for easy writing for extended periods. Available in 8 colors of writing, medium tip.



Esferográfica Superfun

Esferográfica retráctil com corpo e clip transparente, de grip ergonómico em borracha que facilitará a escrita em períodos prolongados. Disponível em 8 cores de escrita, ponta média.

Stylo bille Smoothy

Stylo bille bleu avec revêtement en plastique ultra doux et doux pour une écriture plus rapide et plus lisse. Permet un flux d'encre constant du début à la fin. Qualité Premium.

Bolígrafo Smoothy

Bolígrafo de color azul, con revestimiento de plástico "soft touch" de tinta ultra suave, para una escritura más rápida y suave. Permite un flujo de tinta consistente de su inicio al final. De Calidad Premium.

Stylo bille Superfun

Stylo bille rétractable avec corps transparent et clip, poignée en caoutchouc ergonomique pour une saisie facile pendant de longues périodes. Disponible en 8 couleurs d'écriture, pointe moyenne.

Bolígrafo Superfun

Esferográfica retráctil con cuerpo y clip transparente, de agarre ergonómico en goma que facilitará la escritura en períodos prolongados. Disponible en 8 colores de escritura, punta media.

ITEM	REF.	Color	Ballpoint	Retractable	Ballpoint	Retractable
001004081899	818-99	Blue	✓	✓	36	1

ITEM	REF.	Color	Ballpoint	Retractable	Ballpoint	Retractable
001004082899	828-99	3x 3x 3x 3x 3x 3x 3x 3x	✓	✓	24	1



6555 Retractable ballpoint pen

Retractable pen, push button, grip no fatigue.

Esferográfica retráctil 6555

Esferográfica de ponta retráctil, botão de pressão, clip e punho anti-fadiga.

Stylo bille retractable 6555

Stylo bille retractable, bouton poussoir, clip, grip antiglisse.

Bolígrafo retráctil 6555

Bolígrafo retráctil, pulsador, clip, zona de agarre antideslizante.

ITEM	REF.				
00100465501	6555-11		<input checked="" type="checkbox"/>	<input checked="" type="checkbox"/>	<input checked="" type="checkbox"/>
00100465502	6555-11		<input checked="" type="checkbox"/>	<input checked="" type="checkbox"/>	<input checked="" type="checkbox"/>
00100465503	6555-11		<input checked="" type="checkbox"/>	<input checked="" type="checkbox"/>	<input checked="" type="checkbox"/>
00100465504	6555-11		<input checked="" type="checkbox"/>	<input checked="" type="checkbox"/>	<input checked="" type="checkbox"/>
00100465599	6555-BLT4-1		<input checked="" type="checkbox"/>	<input checked="" type="checkbox"/>	<input checked="" type="checkbox"/>



Line ball 7 ballpoint pen

Ballpoint pen with plastic body and cap, metallic tip and water resistant ink, provides a consistent and smooth writing.

Esferográfica Line ball 7

Esferográfica de escrita fina, suave e traço constante, clip e corpo plástico transparente, ponta metálica e tinta pigmentada resistente à água.

Stylo bille Line ball 7

Stylo bille avec corps et capuchon en plastique, pointe métallique et encre résistant à l'eau. Permet une écriture uniforme et lisse.

Bolígrafo Line ball 7

Bolígrafo con cuerpo y tapón de plástico, punta metálica y tinta resistente al agua, proporciona una escritura constante y suave.

ITEM	REF.				
0010047001	Line Ball 7		<input checked="" type="checkbox"/>	<input checked="" type="checkbox"/>	<input checked="" type="checkbox"/>
0010047002	Line Ball 7		<input checked="" type="checkbox"/>	<input checked="" type="checkbox"/>	<input checked="" type="checkbox"/>
0010047003	Line Ball 7		<input checked="" type="checkbox"/>	<input checked="" type="checkbox"/>	<input checked="" type="checkbox"/>
0010047004	Line Ball 7		<input checked="" type="checkbox"/>	<input checked="" type="checkbox"/>	<input checked="" type="checkbox"/>
00100470099	LINE7-BLT4-1		<input checked="" type="checkbox"/>	<input checked="" type="checkbox"/>	<input checked="" type="checkbox"/>



Line 1 ballpoint pen

Ballpoint pen with round and clear barrel, a non-slip metal tip and ventilated cap.

Esferográfica Line 1

Esferográfica de corpo redondo, ponta metal anti-derrapante e tampa ventilada.

Stylo bille Line 1

Stylo bille avec corps arrondi, pointe métallique antiglisse et capuchon ventilé.

Bolígrafo Line 1

Bolígrafo con cuerpo redondo, punta de metal anti-derrapante y tapón ventilado.

ITEM	REF.				
00100410012	CX12-LINE1A		<input checked="" type="checkbox"/>	<input checked="" type="checkbox"/>	<input checked="" type="checkbox"/>
001004100212	CX12-LINE1P		<input checked="" type="checkbox"/>	<input checked="" type="checkbox"/>	<input checked="" type="checkbox"/>
001004100312	CX12-LINE1VM		<input checked="" type="checkbox"/>	<input checked="" type="checkbox"/>	<input checked="" type="checkbox"/>
001004100412	CX12-LINE1VD		<input checked="" type="checkbox"/>	<input checked="" type="checkbox"/>	<input checked="" type="checkbox"/>
00100499963	LINE1-BLT4-1	4x	<input checked="" type="checkbox"/>	<input checked="" type="checkbox"/>	<input checked="" type="checkbox"/>
00100499964	LINE1-BLT4-2	4x	<input checked="" type="checkbox"/>	<input checked="" type="checkbox"/>	<input checked="" type="checkbox"/>
00100499965	LINE1-BLT4-3		<input checked="" type="checkbox"/>	<input checked="" type="checkbox"/>	<input checked="" type="checkbox"/>

ITEM	REF.				
0010041399	LINE1-BLT3-1		<input checked="" type="checkbox"/>	<input checked="" type="checkbox"/>	<input checked="" type="checkbox"/>
00100499901	LINE1-BLT3-2	3x	<input checked="" type="checkbox"/>	<input checked="" type="checkbox"/>	<input checked="" type="checkbox"/>
00100499902	LINE1-BLT3-3	2x	<input checked="" type="checkbox"/>	<input checked="" type="checkbox"/>	<input checked="" type="checkbox"/>
00100499903	LINE1-BLT3-4	2x	<input checked="" type="checkbox"/>	<input checked="" type="checkbox"/>	<input checked="" type="checkbox"/>
00100499904	LINE1-BLT3-5	3x	<input checked="" type="checkbox"/>	<input checked="" type="checkbox"/>	<input checked="" type="checkbox"/>
0010041599	LINE1-BLT5-1	2x	<input checked="" type="checkbox"/>	<input checked="" type="checkbox"/>	<input checked="" type="checkbox"/>
00100499918	LINE1-BLT5-2	3x 2x	<input checked="" type="checkbox"/>	<input checked="" type="checkbox"/>	<input checked="" type="checkbox"/>
00100499919	LINE1-BLT5-3	3x 2x	<input checked="" type="checkbox"/>	<input checked="" type="checkbox"/>	<input checked="" type="checkbox"/>



Grip gel 707 ballpoint pen

Gel ink pen, rubber grip and ventilated cap.

Esferográfica grip gel 707

Esferográfica tinta gel, punho borracha anti-fadiga e tampa ventilada.

Stylo encre gel 707

Stylo encre gel, grip caoutchouté et capuchon ventilé.

Bolígrafo grip gel 707

Bolígrafo tinta gel, empuñadura de caucho y tapón ventilado.

ITEM	REF.				
001004070701	707		<input checked="" type="checkbox"/>	<input checked="" type="checkbox"/>	<input checked="" type="checkbox"/>
001004070702	707		<input checked="" type="checkbox"/>	<input checked="" type="checkbox"/>	<input checked="" type="checkbox"/>
001004070703	707		<input checked="" type="checkbox"/>	<input checked="" type="checkbox"/>	<input checked="" type="checkbox"/>
001004070704	707		<input checked="" type="checkbox"/>	<input checked="" type="checkbox"/>	<input checked="" type="checkbox"/>
001004070799	707-BLT4-1		<input checked="" type="checkbox"/>	<input checked="" type="checkbox"/>	<input checked="" type="checkbox"/>



Rollerball thin R150

Liquid ink roller, stainless steel and polypropylene body, ink monitoring window, no fatigue grip and ventilated cap. Quick drying.

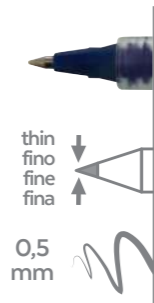

Marcador roller Fino R150

Marcador de tinta à base de água, ponta de aço inoxidável, corpo em polipropileno com zona de manuseamento anti-fadiga e visor do nível da tinta.

Roller Fine R150

Roller encre liquide avec la pointe en acier inoxydable et le corps en polypropylène, niveau d'encre visible, grip ergonomique et capuchon ventilé.

Roller Fino R150

Marcador con punta de acero inoxidable (0,5mm) con cuerpo en polipropileno con zona inferior que reduce la fatiga al escribir, visor del nivel de tinta.

ITEM	REF.				
15100415001	R1605F		✓	12	144
15100415002	R1605F		✓	12	144
15100415003	R1605F		✓	12	144
15100415004	R1605F		✓	12	144



Ink gel marker

Gel ink marker in transparent barrel with ergonomic rubber grip and clip in ink color. Very smooth, fluid and precise writing.



Marcador gel

Marcador de tinta gel, corpo transparente, facilita a visualização do nível de tinta existente, pega ergonómica para um manuseamento fácil e escrita fluida.

Marqueur encre gel

Marqueur à encre gel pigmentée résistante à l'eau avec une zone grip pour un meilleur confort. Écriture fluide, régulière et confortable.

Marcador tinta gel

Marcador de tinta gel de buena calidad con cuerpo transparente que facilita la visualización del nivel de tinta existente, goma ergonómica en el inferior para una fácil escritura.

ITEM	REF.				
151004160501	Gelink		✓	12	1200
151004160502	Gelink		✓	12	1200
151004160503	Gelink		✓	12	1200
151004160504	Gelink		✓	12	1200

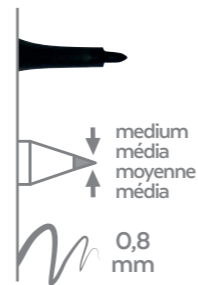

Fibraliner pen 120

Felt-tip pen with water-based ink, won't bleed through paper, pp colored triangular barrel and ventilated cap.

Marcador fibraliner 120

Marcador de ponta de fibra com tinta à base de água, não trespassa o papel, corpo em PP, opaco, no formato triangular. Tampa de fecho ajustável e hermética.

ITEM	REF.				
15100412001	120		✓	12	432
15100412002	120		✓	12	432
15100412003	120		✓	12	432
15100412099	120-12		✓	1	12
151004120994	120-BLT4		✓	1	12



Stylo feutre fibre 120

Stylo feutre à pointe en fibre nylon, encre à base d'eau. Ne traverse pas le papier, corps en pp, coloré, triangulaire et capuchon ventilé.



Rotulador fibra 120

Rotulador punta de fibra con tinta en base de agua, que no respase el papel, cuerpo en pp, opaco, triangular y capuchón ventilado.



Fineliner pen 880

Fibre point pen with water-based ink, metal enclosed tip, opaque triangular barrel and ventilated cap.

Marcador fineliner 880

Marcador de ponta de fibra, com protecção metálica, tinta à base de água, corpo em PP, opaco, no formato triangular. Tampa ventilada e hermética.



Stylo feutre pointe fine 880

Stylo feutre à pointe fine, pointe avec protection métallique, corps opaque triangulaire et capuchon ventilé.

Rotulador punta fina 880

Rotulador punta de fibra con refuerzo metálico, tinta de base acuosa, cuerpo en pp, opaco, triangular y capuchón ventilado.

ITEM	REF.				
15100488001	880		✓	12	432
15100488002	880		✓	12	432
15100488003	880		✓	12	432
15100488004	880		✓	12	432
15100488099	880-12		✓	1	12
151004880994	880-BLT4		✓	1	12



Permanent marker P300

Marker for permanent writing and marking on all surfaces. Smudge-proof and water-resistant. Quick drying. Polypropylene barrel and ventilated cap at the ink color.



Marcador permanente P300

Marcador de ponta redonda com tinta permanente à base de álcool, corpo em polipropileno, tampa ventilada e hermética para evitar secagem da tinta.



Marqueur permanent P300

Marqueur permanent multiusage, sans odeur, résiste à l'eau et séchage très rapide. Corps en polypropylène. Le capuchon identifie la couleur. Le capuchon est ventilé et hermétique.

Marcador permanente P300

Marcador de punta redonda con tinta permanente al base de alcohol, cuerpo en polipropileno, capuchón ventilada y hermética.

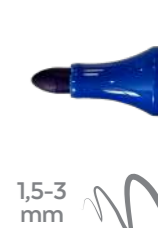

ITEM	REF.				
15100430001	P300		✓	12	1200
15100430002	P300		✓	12	1200
15100430003	P300		✓	24	1200
15100430004	P300		✓	12	1200
151004300992	P300-BLT2-1		✓	1	12
151004300993	P300-BLT2-2		✓	1	12



Universal marker pen dual tip

Universal dual tip permanent marker (fine and medium). Resistant to water and dirt, quick drying odorless ink. Body in PP, cover in writing color.

Marcador universal duas pontas

Marcador permanente universal de duas pontas (fina e média). Resistente à água e à sujidade, tinta sem odor de secagem rápida. Corpo em PP, tampa da cor da escrita.

Feutre universel à deux points

Marqueur permanent universel à deux points (fin et moyen). Résistant à l'eau et à la saleté, encre inodore à séchage rapide. Corps en PP, couverture en couleur d'écriture.

Rotulador universal dos pontos

Rotulador permanente universal de dos puntos (fino y medio). Resistente al agua y la suciedad, tinta inodoro de secado rápido. Cuerpo en PP, tapa en color escritura.

ITEM	REF.					
08400431601	316		✓	12	6	864
08400431602	316		✓	12	6	864
08400431603	316		✓	12	6	864



thin
fino
fine
fina
0,6 mm

medium
média
moyenne
média
1,0 mm



Highlighter office F100

High quality ink pad highlighter with straight lines, constante flow of ink, PP body with an ergonomic zone, ventilated cap with clip.



Sublinhador fluorescente office F100

Marcador fluorescente universal com pigmentos de alta qualidade, corpo em polipropileno, zona de manuseamento anti-fadiga, tampa ventilada e hermética com clip.



Rotulador fluorescente office F100

Encre fluorescente universelle à base d'eau, corps en polypropylène, ergonomique, capuchon ventilé avec clip. Résiste à la lumière.

Rotulador fluorescente universal con pigmentos de alta calidad, cuerpo en polipropileno, zona anti fatiga para la escritura, punta biseleada, capuchón ventilada y hermética con clip.

ITEM	REF.					
14900410001	F100		✓	12	6	48
14900410004	F100		✓	12	6	48
14900410005	F100		✓	12	6	48
14900410008	F100		✓	12	6	48
14900410009	F100		✓	12	6	48
1490041002	F100-BLT2		✓	2	1	12
1490041003	F100-BLT3		✓	3	1	8



Highlighter junior F50

High quality liquid ink highlighter with polypropylene barrel, ventilated cap with clip, light resistant, smudge proof and quick-drying.



Sublinhador fluorescente júnior F50

Marcador de fibra, tinta fluorescente universal à base de água de alta luminosidade, corpo em PP, opaco, fino, tampa ventilada.



Surligneur junior F50

Encre fluorescente universelle à base d'eau, résiste à la lumière, corps en polypropylène. Séchage rapide.

Rotulador fluorescente júnior F50

Marcador tinta fluorescente universal à base de água de alta luminosidade, cuerpo em PP, opaco, fino, capuchón ventilado.

ITEM	REF.					
14900450012	CX12-F50AZ		✓	12	10	40
14900450042	CX12-F50VD		✓	12	10	40
14900450052	CX12-F50AM		✓	12	10	40
14900450082	CX12-F50LJ		✓	12	10	40
14900450092	CX12-F50RS		✓	12	10	40
14900450991	F50-BLT3		✓	3	1	12
14900450992	F50-BLT5		✓	5	1	12



Highlighter pastel F55

High quality liquid ink highlighter with ventilated cap with clip, pastel colors, smudge proof and quick-drying.



Sublinhador pastel F55

Marcador de fibra, tinta universal cores pastel, opaco, fino, tampa ventilada.



Highlighter pastel F75

High quality ink pad highlighter with straight lines, constante flow of ink, PP body, ventilated cap with clip. In pastel colors.



Sublinhador pastel F75

Marcador pastel universal con pigmentos de alta calidad, cuerpo em polipropileno, tampa ventilada e hermética com clip. Cores pastel.

Surligneur pastel F55

Encre universelle avec couleurs pastel, corps en polypropylène. Séchage rapide.

Rotulador pastel F55

Marcador tinta universal de colores pastel, opaco, fino, capuchón ventilado.

ITEM	REF.					
1490045505	F55		✓	12	144	864
1490045512	F55		✓	12	144	864
1490045509	F55		✓	12	144	864
1490045508	F55		✓	12	144	864
1490045504	F55		✓	12	144	864
1490045501	F55		✓	12	144	864
1490045599	F55-99		✓	EXP. 24	-	-

Surligneur pastel F75

Encre universelle à base d'eau, corps en polypropylène, capuchon ventilé avec clip. Résiste à la lumière. Couleurs pastel.

Rotulador pastel F75

Rotulador universal con pigmentos de alta calidad, cuerpo en polipropileno, punta biseleada, capuchón ventilada y hermética con clip. Colores pastel.

ITEM	REF.					
1490047505	F75		✓	12	72	432
1490047512	F75		✓	12	72	432
1490047509	F75		✓	12	72	432
1490047508	F75		✓	12	72	432
1490047504	F75		✓	12	72	432
1490047501	F75		✓	12	72	432
1490047599	F75-99		✓	EXP. 24	-	-



Pocket Correction roller

Compact and minimal design correction roller, very good coverage and immediate overwriting.

Fita corretora Pocket

Fita de correção compacta e minimalista, com deslizamento suave, correção em seco e reescrita imediata.

Roller de correction Pocket

Rouleau correcteur compact et de conception minimale, très bonne couverture et écrasement immédiat.

Cinta correctora Pocket

Rodillo corrector de diseño compacto y minimalista, muy buena cobertura y sobrescritura inmediata.

ITEM	REF.	mm	mm	mm
0630045600	5600	5mmx6mt	24	432

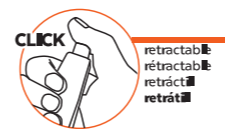

Correction roller

Retractable correction tape, ultra-smooth glide, dry correction and immediate rewrite.

Fita corretora

Fita de correção retráctil, deslizamento ultra suave, correção em seco e reescrita imediata.

Roller de correction

Bande de correction rétractable, glissement ultra-lisse, correction à sec et réécriture immédiate.

Cinta correctora

Cinta de corrección retráctil, deslizamiento ultra suave, corrección en seco y reescritura inmediata.

ITEM	REF.	mm	mm	mm	mm	mm
0630044265	4265	5MMx6MT	✓	✓	✓	24 432
063004426599	4265-99	5MMx6MT	✓	✓	✓	24 12



Correction roller

Correction roller with sideways system, very good coverage and immediate overwriting.

Fita corretora

Fita de correção com sistema 'sideway', deslizamento suave, correção em seco e reescrita imediata.

Roller de correction

Roller avec 'sideway' système (utilisation latérale), correction instantanée et réécriture immédiate.

Cinta correctora

Cinta correctora con sistema 'sideway', deslizamiento suave, corrección en seco y reescritura inmediata.

ITEM	REF.	mm	mm	mm
0630044280	4280	5mmx8mt	36	576



Correction roller

Correction tape with smooth slip, dry correction and immediate rewrite.

Fita corretora

Fita de correção com deslizamento suave, correção em seco e reescrita imediata.



Roller de correction

Bande de correction avec glissement lisse, correction à sec et réécriture immédiate.



Cinta correctora

Cinta de corrección con deslizamiento suave, corrección en seco y reescritura inmediata.

ITEM	REF.	mm	mm	mm	mm	mm
0630044285	4285	5MMx8MT	✓	✓	✓	12 288
063004428599	4285-99	5MMx8MT	✓	✓	✓	24 12



Correction pen

Correction pen with fine metal tip for precise and clean correction. Quick drying fluid.

Caneta corretora

Corretor com ponta metálica fina, tampa ajustável e corpo flexível.

Stylo correcteur

Stylo correcteur avec une pointe fine en métal, fort pouvoir couvrant, séchage rapide. Réécriture facile.

Lápis corrector

Corrector em forma de lápis, com ponta metálica fina, tampa ajustável e cuerpo flexible.

ITEM	REF.	mm	mm	mm	mm
0630046308	6308	8mm	✓	12	576
06300499904	6308-BLT1	8mm	✓	1	12



Eco Pastel graphite pencil

Wooden graphite pencil with eraser. Available in 8 pastel colors, with triangular shape, very ergonomic and easy-to-handle, HB lead.

Lápis grafite Eco Pastel

Lápis grafite em madeira com borracha. Apresenta-se em 8 cores pastel, no formato triangular muito ergonómico e fácil de manusear, na graduação HB.

Crayon graphite Eco Pastel

Crayon graphite en bois avec gomme. Disponible en 8 couleurs pastel, de forme triangulaire, très ergonomique et maniable, plomb HB.

Lápis grafite Eco Pastel

Lápis de grafite de madeira com goma de borrar. Disponible en 8 colores pastel, con forma triangular, muy ergonómico y fácil de manejar, plomo HB.

ITEM	REF.	Nº	mm	mm	mm	mm	mm	mm
0940020945	094-P	2	HB	✓	72	1	40	



Black lead pencil

Black lead pencil with hexagonal body. Break resistant thanks to super-bonded lead. Easy to erase and to sharpen.

Lápis grafite

Lápis grafite com corpo hexagonal e mina resistente à quebra. A sua qualidade permite apagar e afiar facilmente.

Crayon graphite

Crayon hexagonal pour le bureau. Taillage et gommage facile. Mine résistante.

Lápis grafito

Lápis grafite de alta calidad, con cuerpo hexagonal y mina de alta resistencia a la rotura. Su calidad permite eliminar y afilar fácilmente.

ITEM	REF.	Nº	mm	mm	mm	mm
0940020000	-	0	2B	✓	12	144
0940020001	-	1	B	✓	12	144
0940020002	-	2	HB	✓	12	144
0940020003	-	3	H	✓	12	144
0940020004	-	4	2H	✓	12	144
0940025002	094-BLT3-1	1/2/3	B/HB/H	✓	3	24
09400299920	094-BLT3-2	2	HB	✓	3	24



Eco Max graphite pencil

Wood-free pencil in synthetic resin material, hexagonal body, ultra resistant, non breaking HB lead and easy to handle. Accurate and smooth writing, easy to erase.

Lápis grafite Eco Max

Lápis grafite em resina, sem madeira, no formato hexagonal, ultra-resistente, uma vez que não quebra com facilidade e não lascas. Apresenta-se na graduação 2/HB, proporcionando uma escrita macia, precisa e fácil de apagar.

Crayon graphite Eco Max

Crayon sans bois en matériau de résine synthétique, corps hexagonal, ultra résistant et facile à manipuler. Plomb anti-casse. Écrit précise et lisse, facile à effacer.

Lápis grafito Eco Max

Lápis de resina sintética, libre de madeira, cuerpo hexagonal, resistente a la ruptura y fácil de manejar. Escritura precisa y suave, fácil de borrar.

ITEM	REF.	Nº	mm	mm	mm	mm
0940020941	094-M	2	HB	✓	12	240
094002309411	094M-BLT3-1	2	HB	✓	3	24



Eraser

Soft white eraser with slide sleeve for graphite pencils. Erases smoothly and comfortably without damaging the paper thanks to its 'softy' texture.

Borracha para lápis

Borracha branca retangular macia para apagar traços de lápis, limpa suavemente sem sujar ou danificar.

Gomme

Gomme blanche pour crayon graphite, très douce, rectangulaire avec bague de protection. Effaçage propre et précis quasiment sans dégât le papier.

Goma de borrar

Goma rectangular 'softy' para acabar con trazos de lápis sobre el papel. Limpia suavemente sin ensuciar o dañar.



ITEM	REF.	mm	mm	mm	mm
0260022607	2607	60x23x12mm	✓	20	480
0260023260	3260	40x23x12mm	✓	30	720
0260020002	2607-BLT2	-	✓	1	20
0260020003	3260-BLT2	-	✓	1	20



Eraser pen

White eraser pen style holder, retractable and refillable, PP translucent barrel with anti-slip grooves and clip. Ideal for graphite on paper and matte drafting film.

Porta apagador

Porta apagador tipo caneta, retráctil e recarregável, em polipropileno rígido, zona de manuseamento com estrias anti-deslizante e clip plástico. Ideal para apagar lápis sobre qualquer tipo de papel ou película de desenho.

Porte gomme rechargeable

Stylo porte gomme, blanc, en pp, retractable et rechargeable, avec des rainures antidérapantes et clip. Ne laisse aucune trace sur le support (papier ou pellicule de dessin).

Portagoma

Porta lápis borrador, em pp, retráctil y recargable, con ranhuras antideslizantes y clip. Ideal para borrar lápiz sobre cualquier tipo de papel o película de dibujo.



Eraser pen refill

White eraser refill to eraser pens.

Recarga para porta apagador

Recarga de borracha branca para porta apagadores.

Recharge pour porte gomme

Recharge de gomme blanc pour porte gomme.

Recarga para portagoma

Recarga de goma blanca para portagomas.

ITEM	REF.	mm	mm	mm
0260022620	2620	125mm	50	1000

ITEM	REF.	mm	mm	mm
0260022624	2624	125mm	24	384



Premium Quality Eraser

Super soft white eraser with slide sleeve for graphite pencils. Erases smoothly and comfortably without damaging the paper thanks to its premium quality.

Borracha para lápis qualidade premium

Borracha branca super macia com manga deslizante para lápis de grafite. Apaga suave e confortavelmente sem danificar o papel graças à sua qualidade superior.

Gomme première qualité

Gomme blanche super douce avec gaine coulissante pour crayons graphite. Efface en douceur et confortablement sans abîmer le papier grâce à sa qualité supérieure.

Goma de borrar calidad superior

Goma blanca supersuave con funda deslizante para lápices de grafito. Borra suave y cómodamente sin dañar el papel gracias a su calidad premium.

ITEM	REF.	mm	mm	mm	mm
0260040263	0263	-	✓	20	-
0260040262	0262	-	✓	30	-
02600402632	0263-BLT2	-	✓	1	-
02600402622	0262-BLT2	-	✓	1	-
0260043002	3002	-	✓	30	-



Storage pencil sharpener

2 Holes plastic pencil sharpener, with metallic sharpener, ideal for 8 and 11mm pencils. Transparent storage area to catch wastings.

Afia com depósito

Afia plástica de 2 bocas, com afia dupla metálica, ideal para lápis de 8mm e 11mm. Com um depósito transparente para guardar as aparas.

Taille-crayon avec réservoir

Taille-crayon em plástico avec 2 usage, avec taille-crayon métallique, idéal pour les crayons de 8 et 11 mm. Réservoir de récupération très pratique.

Sacapuntas com depósito

Sacapuntas em plástico com 2 bocas, com 2 bocas de entrada, ideal para lápices de 8 mm y 11 mm. Con un depósito transparente para almacenar las minas atascadas.

ITEM	REF.	mm	mm	mm	mm
0290026009	6009	8mm	11mm	✓	12
02900260091	6009-BLT	8mm	11mm	✓	1



Plastic pencil sharpener

Plastic pencil sharpener with single hole, with grip rubber.

Afia plástica

Afia para lápis em plástico com uma boca, com grip em borracha.

Taille-crayon plastique

Taille-crayon en plastique avec un seul usage, avec grip caoutchouc.

Sacapuntas plástica

Sacapuntas en plástico com uma boca de entrada, grip em goma.

ITEM	REF.	Material	Unit	Box
0290029002	9002	Plastic	36	1440

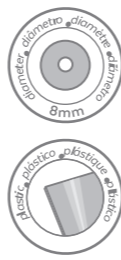

Storage pencil sharpener

Single hole plastic pencil sharpener, with plastic sharpener and storage area to catch wastings.

Afia com depósito

Afia plástica de 1 boca, com afia plástica e um depósito para guardar as aparas.

Taille-crayon avec réservoir

Taille-crayon en plastique avec 1 usage et un réservoir de récupération très pratique.

Sacapuntas con depósito

Sacapuntas en plástico com uma boca de entrada e um depósito para las minas atascadas.

ITEM	REF.	Material	Unit	Box
0290026023	6023	Plastic	24	1440
02900260231	6023-BLT	Plastic	1	288



Mechanical pencil

Refillable mechanical pencil with a retractable point, push-button, clip and rubber. 3 mines included.

Lapiseira

Lapiseiras recarregáveis retrateis com clip, botão de pressão, borracha incorporada. Contem 3 minas.

Porte-mines

Porte-mines rechargeable avec poussoir, clip, grip caoutchouc antiglisse, gomme incorporée. Contient 3 mines.

Portaminas

Portaminas recargable con un agarre en caucho en la parte inferior, pulsador, clip y goma. Incluye 3 minas.

ITEM	REF.	Lead	Material	Unit	Box
0280040155	L155	0,5mm	Plastic	12	-
0280040175	L175	0,7mm	Plastic	12	-
0280040195	L155 + L175	0,5mm + 0,7mm	Plastic	12	-

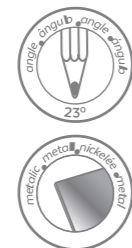

Metal pencil sharpener

Single and 2 holes pencil sharpener. Very resistant blades.

Afia metálica

Afia metálica de 1 e 2 bocas para lápis.

Taille-crayon métallique

Taille-crayon en métal avec 1 et 2 usage pour crayons.

Sacapuntas metálico

Sacapuntas metálico com uma e 2 bocas de crayons.

ITEM	REF.	Unit	Box
0290022901	2901	24	1440



Scholar mechanical pencil

Refillable mechanical pencil with built-in rubber and clip, side click side push button for mine advance without interrupting writing. HB lead.

Lapiseira escolar

Lapiseiras recarregáveis com borracha incorporada e clip, botão de pressão lateral 'side click' para um avanço de mina sem interromper a escrita. Mina HB.

Porte-mines de l'école

Porte-mines rechargeable avec gomme par effacer et clip intégrés, bouton poussoir latéral à clic latéral pour l'avancement de la mine sans interrompre l'écriture. HB mine.

Portaminas escolar

Portaminas recargable con goma incorporada y clip, botón de clic lateral para avance de mina sin interrumpir la escritura. Mina HB.

ITEM	REF.	Lead	Material	Unit	Box
028004018899	L188	1,3mm	Plastic	48	24



Technic Mechanical pencil

Refillable mechanical pencil with a retractable point, push-button, clip and rubber grip. 3 mines included and eraser.

Lapiseira Technic

Lapiseiras recarregáveis retrateis com clip, botão de pressão, grip de borracha incorporada. Contem 3 minas e borracha.

Technic Porte-mines

Porte-mines rechargeable avec une pointe rétractable, un bouton-poussoir, un clip et un grip en caoutchouc. 3 mines incluses et gomme.

Portaminas Technic

Portaminas recargable con punta retráctil, pulsador, clip y empuñadura de goma. Incluye 3 minas y goma de borrar.

ITEM	REF.	Lead	Material	Unit	Box
0280042005	technic05	0,5mm	Plastic	12	-
0280042007	technic07	0,7mm	Plastic	12	-
02800420024	technic05 + technic07	0,5mm + 0,7mm	Plastic	12	-



Pencil leads

Tube with 12 smooth, strong and sharp pencil leads designed to be resistant to breakage. Great opacity and intense lines.

Minas

Tubo com 12 minas de elevada qualidade com grande resistência à quebra e extraordinária suavidade. Grande opacidade e linhas intensas.

Mines

Tube de recharge avec grand solidité, densité et douceur. Offrant un trace fluid et lignes intenses.

Minas

Tubo con 12 minas de alta calidad con alta resistencia a la rotura y extraordinaria suavidad. Gran opacidad y líneas intensas.

ITEM	REF.	Lead	Material	Unit	Box
0270042705	2705	0,5mm	HB	12	12 144
0270040005	2705-BLT2	0,5mm	HB	2	1 25
0270042707	2707	0,7mm	HB	12	12 144
0270040007	2707-BLT2	0,7mm	HB	2	1 25

EXPLORE

EXPLORAR

EXPLORER

EXPLORARE



Eco Colors Colored pencils

Hexagonal resin colored pencils, wood free, with an ultra resistant lead. Their bright and intense colors provide a different sketch and perfect finish.

Lápis de cor Eco Colors

Lápis de cor em resina, sem madeira, hexagonais com mina ultra-resistente. As cores vivas e intensas garantem um traçado diferente com acabamento perfeito.

Crayons de couleur Eco Colors

Crayons de couleur en resine, sans bois, dans le forme hexagonale et avec une mine résistante. Ses couleurs vives et forts assurent une écriture fluide et une finition parfaite.

Lápices de colores Eco Colors

Lápices de colores, libres de madeira, ultra resistentes. Sus colores brillantes y vivos proporcionan un dibujo diferente y acabado perfecto.

ITEM	REF.	mm				
096002962061	E96206C	80mm	2,3mm	6	12	720
096002962121	E96212C	80mm	2,3mm	12	12	360
09600296212	E96212	180mm	2,3mm	12	6	192
09600296224	E96224	180mm	2,3mm	24	6	120



Eco Colors Jumbo Color pencils

Resin wood free color pencils, triangular shape, thick with ultra-resistant mine. Designed especially for small children's hands. Bright and vivid colors assure a different trace with perfect finish.

Lápis de cor Eco Colors Jumbo

Lápis de cor em resina, sem madeira, grossos e de forma triangular com mina ultra-resistente. Ergonomicamente pensado para os mais novos. As cores vivas e intensas garantem um traçado diferente com acabamento perfeito.

Crayons de couleur Eco Colors Jumbo

Crayons de couleur, sans bois, gros et triangulaires avec mine ultra-résistante. Forme ergonomique pensée pour les plus petits. Les couleurs vives et intenses garantent une ligne différent avec une finition parfaite.

Lápices de colores Eco Colors Jumbo

Lápices de colores en resina, sin madera, triangulares, gruesos con mina ultra-resistente. Diseñado especialmente para las manos de los niños pequeños. Los colores brillantes y vivos aseguran un traza diferente con un acabado perfecto.

ITEM	REF.	mm				
096002962122	E96212J	175mm	4mm	12	12	120

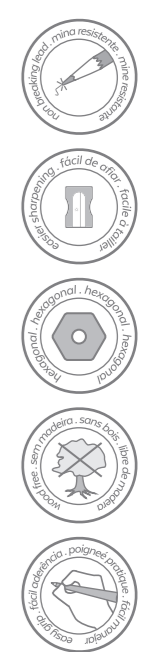



**Colors Pure Nature
Colored pencils**

Wood color pencil, round natural body with 3mm ultra resistant lead. The vivid and intense colors guarantee a different stroke with a perfect finish.

**Lápis de cor
Colors Pure Nature**

Lápis de cor em madeira, corpo redondo na cor natural e mina de 3mm ultra-resistente. As cores vivas e intensas garantem um traçado diferente com acabamento perfeito.

**Crayons de couleur
Colors Pure Nature**

Crayon de couleur en bois, corps rond de couleur naturelle et mine ultra résistante de 3mm. Les couleurs vives et intenses assurent un coup différent avec une finition parfaite.

**Lápices de colores
Colors Pure Nature**

Lápis de color en madera, cuerpo redondo en color natural y mina de 3mm ultra resistente. Los colores vivos e intensos aseguran una traza diferente con un acabado perfecto.

ITEM	REF.	mm	mm	mm	mm	mm
09600296312	96312	175MM	3mm	12	12	144
09600296324	96324	175MM	3mm	24	6	72



Erasable colored pencils

Erasable coloured pencils in 12 or 24 vibrant colours with an eraser pencil included, allowing you to draw, paint and correct easily and effectively. Ergonomic triangular body provides a comfortable and stable grip, ideal for small hands learning to write or for prolonged use. Also available in a special Pastel/Neon edition that offers the best of both worlds: 6 delicate pastel colours and 6 intense neon colours.

Lápis de cor Apagáveis

Lápis de cor apagáveis com 12 ou 24 cores vibrantes e um lápis borracha incluído que permitem desenhar, pintar e corrigir de forma simples e eficaz. Corpo triangular ergonómico proporciona uma pega confortável e estável, ideal para mãos pequenas em fase de aprendizagem ou para utilização prolongada. Também com edição especial Pastel/Neon que o melhor de dois mundos: 6 cores pastel delicadas e 6 cores neon intensas.

Crayons de couleur effaçables

Lápices de colores borrables con 12 o 24 colores vibrantes y un lápiz con goma de borrar incluido que permiten dibujar, pintar y corregir de forma sencilla y eficaz. El cuerpo triangular ergonómico proporciona un agarre cómodo y estable, ideal para manos pequeñas en fase de aprendizaje o para un uso prolongado. También con edición especial Pastel/Neón que ofrece lo mejor de dos mundos: 6 delicados colores pastel y 6 intensos colores neón.

Lápices de colores borrables

Crayons de couleur effaçables avec 12 ou 24 couleurs vives et un crayon gomme inclus qui permettent de dessiner, peindre et corriger de manière simple et efficace. Le corps triangulaire ergonomique offre une prise en main confortable et stable, idéale pour les petites mains en phase d'apprentissage ou pour une utilisation prolongée. Également disponible en édition spéciale Pastel/Neón qui offre le meilleur des deux mondes : 6 couleurs pastel délicates et 6 couleurs néon intenses.

ITEM	REF.	mm	mm	mm	mm	mm
09600496121	9612-A	175mm	8mm	12	12	144
09600496241	9624-A	175mm	8mm	24	6	72
09600496122	9612-B	175mm	8mm	12	12	144
09600496123	9612-C	175mm	10mm	12	6	120



Wax crayons watercolor

Colored wax crayons, watercolored, round, with user's naming labels.

Lápis de cera aquarelável

Lápis de cera aquarelável, redondo, cores vivas. Inclui 12 etiquetas impressas para legendar o lápis com o nome do utilizador.

Craies à la cire aguarable

Craies à la cire, aguarables, arrondie. Comprend 12 étiquettes imprimées pour marquer le nom.

Lápices de cera acquarelable

Lápices de cera acquarelables con 12 etiquetas impresas para leyendar el lápiz con nombre.

ITEM	REF.	mm	mm	mm	mm	mm
0970029712	9712	80mm	8,5mm	12	1	48



Colors Fibre pens

Fibre pen with fine tip (1-2mm) and water-based ink, washable in most fabrics. Round body, ventilated cap and hermetic closure. Available in boxes of 12 and 24 colors.

Marcadores feltro Colors

Marcador de feltro com ponta fina (1-2mm) e tinta à base de água, lavável em todos os tecidos. Corpo redondo, tampa ventilada e hermeticamente fechada. Tonalidade da cor no corpo. Disponível em carteiros de 12 e 24 cores.

Stylos feutres à dessin Colors

Stylo feutre à pointe fine (1-2mm) et encre à base d'eau lavable sur tous les tissus. Corps rond de la même couleur de l'encre, capuchon ventilé de fermeture hermétique. Disponible en étuis de 12 et 24 couleurs.

Rotuladores Colors

Rotuladores con punta fina (1-2 mm) y tinta a base de agua, lavable en la mayoría de los tejidos. Cuerpo redondo, capuchón ventilado y cierre hermético. Disponible en cajas de 12 y 24 colores.

ITEM	REF.	mm	mm	mm
09500295240	95240	24	6	72

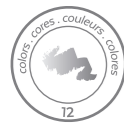

Watercolors

Bright watercolors with good covering power and light resistant. Dilutable with water offers magnificent effects. Commercialized in a set of 12 assorted colors with mixing palette and a brush.

Aquarelas

Estojo com 12 aquarelas com pigmentos de cores vivas, grande rendimento e resistentes à luz. Diluídas em água permite obter efeitos magníficos. Inclui pincel de madeira natural.

Aquarelles

Böîte avec 12 aquarelles fines, pigments d'excellente qualité avec la plus fine taille de grain. Faciles à diluer et à mélanger. Comprend un pinceau en bois naturel.

Acuarelas

Estuje con 12 acuarelas con pigmento de colores vivas, grand rendimiento y resistentes a la luz. Mezcladas con água resultan en efectos magníficos. Pincel incluido.

ITEM	REF.	25mm	12	48
33100233112	33112	<input type="checkbox"/>	<input type="checkbox"/>	<input type="checkbox"/>



Palette

PP anti-break palette with 12 divisions, a hole to place the finger and another to rest the paint brush.

Paleta

Paleta em polipropileno resistente, anti-quebra com 12 divisões, um orifício para colocação do dedo e outro para a colocação do pincel em descanso.

Palette

Palette en polypropylene avec 12 divisions, 1 trou pour placer le doigt et l'autre pour placer le pinceau.

Paleta

Paleta en polipropileno resistente, anti-quebra con 12 divisiones, y uno agujero para colocación del dedo y otro para el pincel.

ITEM	REF.	1	200
037275710002	03702	<input type="checkbox"/>	<input type="checkbox"/>



Extra-fine poster colour

Gouaches aluminium tubes with content of pigmentation. Dilutable with water. All shades can be mixed together, creating chromatic color scale. Great power of hiding and work with regular paper and cardboard.



Guache extra-fino

Guache extra-fino em tubos de 7,5ml, com uma grande concentração de pigmentos que fluem facilmente do pincel. Diluem-se com água e misturam-se facilmente entre si.

Gouache extra-fine

Gouache extra fine en tubes de 7,5 ml, avec une grande concentration des pigments que coulent facilement du pinceau. Son pouvoir couvrant et excellente resistance à la lumière garantissent un excellent rendu.

Guache extra-fino

Guache (têmpera escolar) en tubos de 7,5ml, con una grand concentración de pigmentos, muy fluida, rinde mucho y cubre perfectamente. Se diluyen con agua y se mezcla facilmente con los demás.

ITEM	REF.	7,5ml	5	96
0380025099	13510-99	<input type="checkbox"/>	<input type="checkbox"/>	<input type="checkbox"/>
0380021351002	13510-02	<input type="checkbox"/>	<input type="checkbox"/>	<input type="checkbox"/>
0380021351005	13510-05	<input type="checkbox"/>	<input type="checkbox"/>	<input type="checkbox"/>
0380021351007	13510-07	<input type="checkbox"/>	<input type="checkbox"/>	<input type="checkbox"/>
0380021351068	13510-68	<input type="checkbox"/>	<input type="checkbox"/>	<input type="checkbox"/>
0380021351070	13510-70	<input type="checkbox"/>	<input type="checkbox"/>	<input type="checkbox"/>



Godets

PP anti-break round godets with 3 different sizes.

Godets

Godets redondos em polipropileno resistente, anti-quebra. Apresentam-se em 3 tamanhos diferentes.

Godets

Godets rondes en polypropylene anti-casse disponible dans un jeu de 3 tailles différents.

Godets

Godets redondos em polipropileno resistente, anti-quebra. Disponible en 3 tamaños diferentes.

ITEM	REF.	1	200
037275710007	03707	<input type="checkbox"/>	<input type="checkbox"/>



Paint brushes

Paint brushes with smooth synthetic bristles, wooden handle and nickel plated steel ferrule.

Pincéis

Pincéis com pêlo sintético macio, cabo de cor castanho-noz envernizado e virola de alumínio sem costura.

Pinceaux

Pinceaux avec poils synthétiques, poignée en bois laque et virole nickelée.

Pinceles

Pincel com piel sintética, nogal banizada, cable de color marrón y virola de aluminio sin costuras.

ITEM	REF.	12	200
0370020001	Nº1	<input type="checkbox"/>	<input type="checkbox"/>
0370020002	Nº2	<input checked="" type="checkbox"/>	<input type="checkbox"/>
0370020003	Nº3	<input checked="" type="checkbox"/>	<input type="checkbox"/>
0370020004	Nº4	<input checked="" type="checkbox"/>	<input type="checkbox"/>
0370020005	Nº5	<input checked="" type="checkbox"/>	<input type="checkbox"/>
0370020006	Nº6	<input checked="" type="checkbox"/>	<input type="checkbox"/>
0370020007	Nº7	<input checked="" type="checkbox"/>	<input type="checkbox"/>
0370020008	Nº8	<input checked="" type="checkbox"/>	<input type="checkbox"/>
0370020009	Nº9	<input checked="" type="checkbox"/>	<input type="checkbox"/>
0370020010	Nº10	<input checked="" type="checkbox"/>	<input type="checkbox"/>
0370020011	Nº11	<input checked="" type="checkbox"/>	<input type="checkbox"/>
0370020012	Nº12	<input checked="" type="checkbox"/>	<input type="checkbox"/>
0370020014	Nº14	<input checked="" type="checkbox"/>	<input type="checkbox"/>
0370020016	Nº16	<input checked="" type="checkbox"/>	<input type="checkbox"/>
03700211214	PTB-BLT3-1	<input checked="" type="checkbox"/>	<input type="checkbox"/>
03700213579	PTB-BLT5-1	<input checked="" type="checkbox"/>	<input type="checkbox"/>
037002246810	PTB-BLT5-2	<input checked="" type="checkbox"/>	<input type="checkbox"/>



Finger paint

Fast drying opaque ink. Colors can be mixed up, allowing children to understand notions such as texture and contrast. Washable on clothing and skin with soap and water. Assorted colors.

Tinta para dedos

Tinta opaca, de secagem rápida. As cores podem misturar-se entre si, permitindo à criança ter contacto com noções como textura e contraste. Facilmente removível das mãos e roupa recorrendo a água fria e sabão.

Peinture à doigts

Encre opaque, séchage rapide. Les couleurs peuvent se fondre avec l'autre, permettant à l'enfant d'avoir des contacts avec notions comme texture et contraste. Facilement lavable des vêtements et mains avec du savon et de l'eau.

Pintura de dedos

Pintura opaca, de secado rápido. Los colores se pueden mezclar entre si, permitiendo al niño tener contacto con nociones como textura, contraste. Fácilmente extraíble de manos y ropa recurriendo al agua fría y jabón.



ITEM	REF.	500 ml	6
33100253411	653415	<input type="checkbox"/>	<input type="checkbox"/>
33100253412	653415	<input type="checkbox"/>	<input type="checkbox"/>
33100253413	653415	<input type="checkbox"/>	<input type="checkbox"/>
33100253414	653415	<input type="checkbox"/>	<input type="checkbox"/>
33100253415	653415	<input type="checkbox"/>	<input type="checkbox"/>
33100253416	653415	<input type="checkbox"/>	<input type="checkbox"/>

To be applied with fingers, without using water or other things in any kind of paper.

Aplicar diretamente com os dedos, sem necessidade de recorrer à água, em qualquer tipo de papel.

idéal pour appliquer directement dans quelque papier avec les doigts sans avoir besoin de l'eau.

ideal para aplicar directamente con los dedos sin necesidad de agua en cualquier tipo de papel

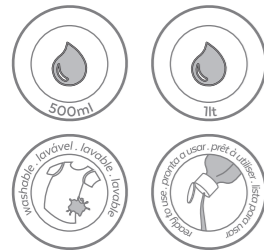

Ready to use paint

Liquid watery gouache ready to use with excellent hiding power. Harmless fast-drying ink. Washable on clothing and skin with soap and water. Resistant to light.

Gouache prêt à l'emploi

Gouache liquide aqueuse prêt à utiliser avec excellent pouvoir couvrant. Séchage rapide et facilement lavable des vêtements et mains avec du savon et de l'eau. Excellente résistance à lumière.

ITEM	REF.	500 ML	1LT	6
03800253281	153285	500 ML		6
03800253282	153285	500 ML		6
03800253284	153285	500 ML		6
03800253285	153285	500 ML		6
03800253287	153285	500 ML		6
03800253288	153285	500 ML		6
038002532810	153285	500 ML		6
038002532811	153285	500 ML		6
038002532812	153285	500 ML		6
038002532813	153285	500 ML		6
038002532814	153285	500 ML		6
038002532815	153285	500 ML		6
03800253341	153341	1LT		6
03800253342	153341	1LT		6
03800253344	153341	1LT		6
03800253345	153341	1LT		6
03800253347	153341	1LT		6
03800253348	153341	1LT		6
038002533410	153341	1LT		6
038002533411	153341	1LT		6
038002533412	153341	1LT		6
038002533413	153341	1LT		6
038002533414	153341	1LT		6
038002533415	153341	1LT		6

Guache pronta

Tinta líquida, opaca e homogênea, pronta a usar, com pigmentos de alta qualidade e excelente poder de cobertura. Secagem rápida e facilmente lavável da roupa e mãos, utilizando água e sabão.

Tempera líquida

Tinta líquida, opaca y homogênea, lista para usar, con pigmentos de alta calidad y un excelente poder de cobertura. Secado rápido y fácilmente lavable en ropa y manos utilizando agua y jabón.

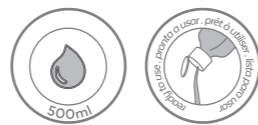

Acrylic paint

Ready to use liquid ink with easy adhesion to all surfaces. After drying provides a bright varnished effect, giving it an artistic touch to the painted piece. It has a smooth consistency and the colors can be mixed together. Washable on clothing and hands with soap and water.

Peinture acrylique

Cette encre liquide prêt à utiliser adhère facilement à toutes les surfaces. Après séchage offre un effet de vernis brillant, donnant une touche artistique à la pièce peinte. Il ya une consistance lisse et les couleurs agréables peuvent être mélangés. Facilement lavable des vêtements et mains avec du savon et de l'eau.

ITEM	REF.	500 ml	6
33100253371	553375	500 ml	6
33100253372	553375	500 ml	6
33100253373	553375	500 ml	6
33100253374	553375	500 ml	6
33100253375	553375	500 ml	6
33100253376	553375	500 ml	6
33100253377	553375	500 ml	6
33100253378	553375	500 ml	6
33100253379	553375	500 ml	6
331002533710	553375	500 ml	6

glass	vidro	le verre	vidrio
plastic	plástico	le plastique	plástico
ceramic	madeira	le bois	madera
wood	cerâmica	ceramique	cerâmica
among others	entre outros	et d'autres	entre otras

Tinta acrílica

Tinta líquida pronta a usar com fácil aderência a todo o tipo de superfície. Depois de seca, proporciona um efeito envernizado brilhante, dando um toque artístico à peça pintada. Sai facilmente das mãos com água morna e sabão.

Tinta acrílica

Tinta líquida con fácil adherencia en toda las superficies. Después del secado se obtiene un efecto lacado brillante, dando un toque artístico a la pieza pintada. Se lava con agua tibia y jabón.



Modelling clay

Pajory modelling clay does not air-dry, temperature-resistant, washable with soap and water. Can be blended into infinite shapes.

Pâte à Modeler

Pât à modeler, ne durit pas même stockée à l'air. Facile à lisser, ferme et dense. Permet de réaliser des modelages précis et minitieux.

Plasticina

Plasticina moldável, não seca ao ar podendo ser trabalhada durante muito tempo. Lavável da roupa e das mãos com água e sabão, é ótima para a criação de pequenas figuras. Não é tóxica.

Plastilina

Plastilina no mancha, no ensucia y se desmolda con grand facilidad. Lavable de ropa y de las manos con agua y jabón. No es toxica.

ITEM	REF.	12	72
10000210012	100/12	12	72



Tracing paper notepad

Tracing paper with a smooth surface, resistant to scrapes and traction. Not yellowing overtime. Ideal for pencil drawing, ink and marker.

Papier calque

Bloc collé en tête avec un papier clair et parfaitement translucide, conçu pour tracer au crayon et à l'encre de chine. 50 feuilles lisses pour calquer quelque supporte.

Bloco papel vegetal

Papel vegetal muito transparente de superficie satinada, resistente às raspagens e à tracção, não amarelece com o passar do tempo.

Bloc papel vegetal

Papel vegetal, transparente, de superficie brilhante, resistente à las raspaduras y à la traccción, no amarillece con el pasar del tiempo.

ITEM	REF.	90	A3	50	10	20
13200239050	-	90	A3	50	10	20
13200249050	-	90	A4	50	10	40



Glossy paper

Glossy paper pad with glossy sheets in one side and white in the other. Ideal for scrapbooks and craft works.

Papier laqué

Bloc avec feuilles de couleurs vives d'un côté, et blanc opaque d'autre côté. Idéal pour des travaux manuels créatifs.

Papel lustro

Bloco de papel colorido brilhante numa face, e outra face branca e baça. Ideal para recortes, colagens e construções especialmente para trabalhos manuais.

Papel charol

Bloco de papel estucado brilhante en un rostro, y otro rostro blanco bazo. Ideal para trabajos manuales.

ITEM	REF.	65	240x320mm	25	25	100
05300253399	-	65	240x320mm	25	25	100



Cardboard pad

Notepad with 10 colored cardboard sheets of 180g/m2, ideal to develop creative craft works. A3 and A4 format. Assorted colours.

Bloc feuilles de cartón bristol

Bloc avec 10 feuilles de bristol 180g/m2 en A3 et A4. Couleurs assorties.

Bloco cartolinas

Bloco com 10 folhas de cartolina colorida de 180g/m2 no formatos A3 e A4. Cores sortidas.

Bloc cartulinas

Bloc con 10 hojas de cartolina cde colores de 180g/m2 en formatos A3 e A4. Colores surtidos.

ITEM	REF.	180	A3	10	30
0510023099	-	180	A3	10	30
0510024099	-	180	A4	20	40



Miscellaneous Papers Pad

This set includes everything from card and glossy paper to cellophane, metallic paper and tissue paper, offering versatility for collages, cut-outs, decorations and art projects.

Bloc de papiers divers

Cet assortiment comprend aussi bien du carton et du papier glacé que du cellophane, du papier métallisé et du papier de soie, offrant ainsi une grande polyvalence pour les collages, les découpages, les décorations et les activités artistiques.

Bloco Papéis Diversos

Este conjunto inclui desde cartolinas e papel de lustrado até celofane, papel metalizado e papel de seda, proporcionando versatilidade para colagens, recortes, decorações e atividades artísticas.

Bloc de papeles varios

Este surtido incluye desde cartulinas y papel brillante hasta celofán, papel metalizado y papel de seda, lo que ofrece una gran versatilidad para collages, recortes, decoraciones y actividades artísticas.



Fegol colouring book

With 25 detachable pages and spiral binding, it is practical and comfortable to use, ideal for children and adults. The 227x240 mm format offers a generous area for coloring, while the high-quality paper ensures good resistance to the use of colored pencils, markers, or pens.

Livre de coloriage Fegol

Avec ses 25 pages détachables et sa reliure spirale, il est pratique et confortable à utiliser, idéal pour les enfants et les adultes. Son format 227 x 240 mm offre une grande surface à colorier, tandis que son papier de qualité garantit une bonne résistance à l'utilisation de crayons de couleur, de marqueurs ou de stylos.

Livro de colorir Fegol

Com 25 páginas destacáveis e encadernação em espiral, permite uma utilização prática e confortável, ideal para crianças e adultos. O formato 227x240 mm oferece uma área generosa para colorir, enquanto o papel de qualidade assegura boa resistência ao uso de lápis de cor, marcadores ou canetas.

Libro para colorear Fegol

Con 25 páginas desprendibles y encuadernación en espiral, permite un uso práctico y cómodo, ideal para niños y adultos. El formato 227 x 240 mm ofrece una generosa superficie para colorear, mientras que el papel de alta calidad garantiza una buena resistencia al uso de lápices de colores, rotuladores o bolígrafos.

ITEM	REF.	g/m ²	folhas	reliure	formato
3330045981	15981	240x320mm	42	-	-

ITEM	REF.	g/m ²	folhas
124004124045	124045	227x240mm	25



Tracing paper notepad

Notepad glued at the head with clear translucent paper, perfect for line drawing, crayon and indian ink works.

Bloco papel esquiço

Bloco de elevada transparência e superfície lisa, colado no topo e capa impressa. Boa resistência a correções e rasgões.

Papier calque

Bloc collé en tête avec un papier clair et parfaitement translucide, conçu pour tracer au crayon et à l'encre de chine.

Bloc papel vegetal

Bloc con papel de elevada transparencia y superficie lisa, pegado en borde y tapa impresa.

ITEM	REF.	g/m ²	formato	folhas	reliure	formato
1320000002	-	55	A2	80	1	5
1320023800	-	55	A3	80	10	20
1320024800	-	55	A4	80	10	40

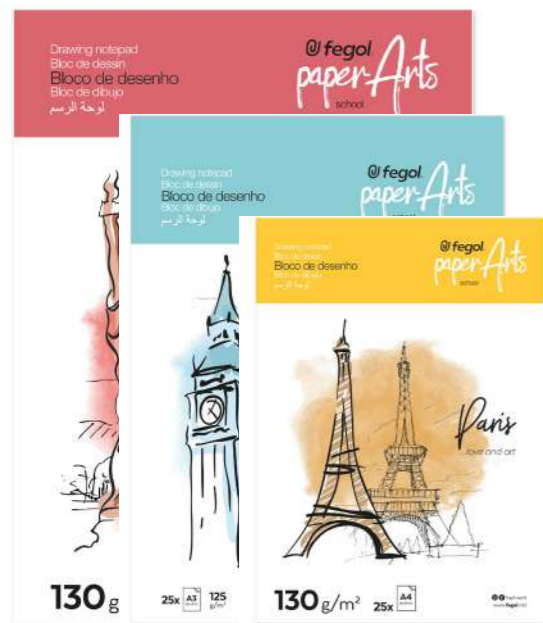

Drawing notepad

Notepad glued at the head with light blank paper sheets of 125g/m², to sketch out or to work with tools like pencils, chalk, pastel, felt tip, nib, ink and even watercolors. Printed cover.

Bloc dessin

Bloc collé en tête permettant un traçage rapide et précis avec feuilles blanches lisses de 125 g/m² idéal pour dessiner avec crayon, craie, pastel, feutre, plume et aquarelle. Couverture imprimée.

Bloco desenho

Bloco escolar de papel desenho branco com 125g/m², sem margens, colado no topo. Capa impressa com plasticização mate. Ideal para desenhos a lápis, pastel, marcadores e giz artístico.

Bloc de dibujo

Bloc escolar de papel dibujo blanco con 125g/m², sin márgens, encolado no topo. Tapa impressa.

ITEM	REF.	g/m ²	folhas	reliure	formato
246002225125	-	A2	25	125	1
246002325125	-	A3	25	125	10
246002425125	-	A4	25	125	10



Spiral drawing notepad

Spiral notepad notepad with light blank paper 160g/m², borderless, microperforated, horizontal, to sketch out or to work with tools like pencils, chalk, pastel, felt tip, nib, ink and even watercolors. Printed cover.

Bloc à spirales dessin

Bloc spirale en papier blanc avec 160g/m², sans bordure, picoré, horizontal. Couverture imprimée avec plastification mate. Idéal pour dessiner avec crayon, craie, pastel, feutre, plume et aquarelle. Couverture imprimée.

Bloco espiral desenho

Bloco espiral de papel desenho branco com 160g/m², sem margens, com picote, na horizontal. Capa impressa com plasticização mate. Ideal para desenhos a lápis, pastel, marcadores e giz artístico.

Bloc espiral de dibujo

Bloc espiral de papel dibujo blanco con 160g/m², sin márgens, con picoteo, en horizontal. Funda impresa con plastificación mate. Ideal para dibujos a lápis, pastel, marcadores y tiza artística.

ITEM	REF.	g/m ²	folhas	reliure	formato
24600231601	-	A3	25	160	10
24600241601	-	A4	25	160	10

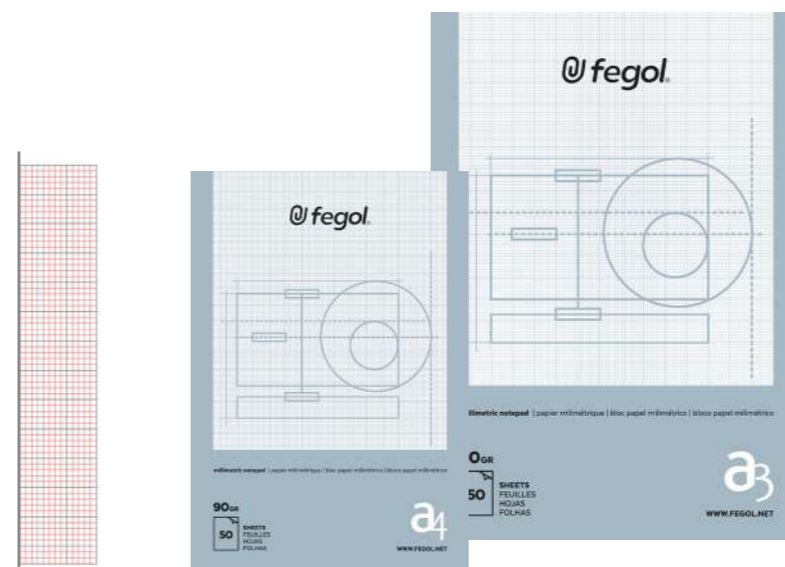

Millimetric notepad

Notepad glued at the head with cream glossy paper of 90g/m², printed with squares designs in a dark colour. Specially conceived to graphic presentations with pencil, ink and nib.

Bloco papel milimétrico

Bloco com papel de cor creme de 90g/m², acetinado e impresso com um desenho milimétrico em cor castanha. Especialmente indicado para representações gráficas com lápis, tinta e pena tubular.

Papier millimetre

Blocs colle en tête de papier satinée 90g/m², imprimé avec dessin millimétrique. Spécialment conçu pour presentation graphic avec crayon et encre.

Bloc papel milimétrico

Bloc de papel color crema, acetinado e impresso con un diseño milimétrico en color castaño. Especialmente indicado para representaciones gráficas con lápis, tinta y pluma.

ITEM	REF.	g/m ²	folhas	reliure	formato
3400020003	-	A3	50	1	10
3400020004	-	A4	50	10	40



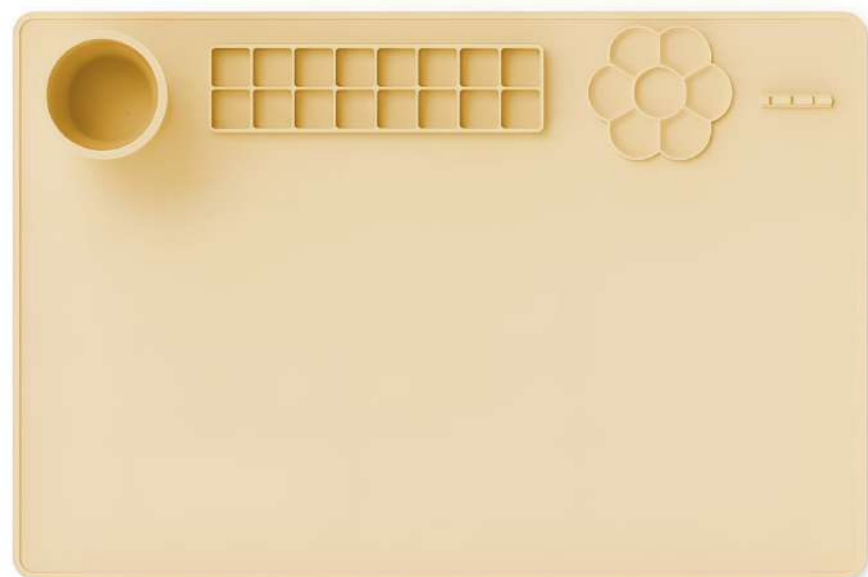

Happy silicone paint mat

Flexible and resistant silicone desk base that protects surfaces from paint, water and dirt. Integrated compartments for paints and accessories. Foldable cup included for water or brush washing. Non-slip.

ITEM	REF.	mm	mm	mm
07900407901	079017	60x40 cm		1

Base pintura happy silicone mat

Base de secretária em silicone flexível e resistente que protege superficies contra tinta, água e sujidade. Compartimentos integrados para tintas e acessórios. Copo dobrável incluído para água ou lavagem de pincéis. Antiderrapante.

Base de peinture Happy Silicone Mat

Base de bureau en silicone souple et résistante qui protège les surfaces contre la peinture, l'eau et la saleté. Compartiments intégrés pour les peintures et les accessoires. Gobelet pliable inclus pour l'eau ou le lavage des pinceaux. Antidérapant.



Base de pintura Happy Silicone Mat

Base de escritorio de silicona flexible y resistente que protege las superficies contra la pintura, el agua y la suciedad. Compartimentos integrados para pinturas y accesorios. Vaso plegable incluido para agua o para lavar pinceles. Antideslizante.



Scholar scissors

High quality light scissors, ergonomic, reinforced by a plastic cable and round tips.

Tesoura escolar

Tesoura leve e ergonómica de elevada qualidade com cabo em plástico reforçado e pontas arredondadas.

Ciseau scolaire

Ciseau léger et ergonomique, renforcé par un câble plastique et pointe arrondi.

Tijera escolar

Tijera elegante, moderna y ergonómica de elevada calidad con cabo de plástico reforzado y puntas redondeadas.

ITEM	REF.	mm	mm	mm
0780020095	TS-95B	5"/13cm	24	288



Titanium scissors

Scissors that combine titanium blades for superior durability with a smooth and precise cut. Ideal for domestic, school or professional use, they guarantee corrosion resistance and long-lasting performance. With an ergonomic design that provides comfort even during prolonged use, making them perfect for detailed work or intensive use.

Tesoura titanium

Tesoura que combina lâminas de Titanium para uma durabilidade superior com um corte suave e preciso. Ideal para utilização doméstica, escolar ou profissional, garante resistência à corrosão e desempenho prolongado. Com design ergonómico que proporciona conforto mesmo em utilizações prolongadas, tornando-a perfeita para trabalhos minuciosos ou de uso intensivo.

Ciseaux en titane

Ciseaux combinant des lames en titane pour une durabilité supérieure et une coupe douce et précise. Idéaux pour un usage domestique, scolaire ou professionnel, ils garantissent une résistance à la corrosion et des performances prolongées. Leur conception ergonomique offre un confort même en cas d'utilisation prolongée, ce qui les rend parfaits pour les travaux minutieux ou intensifs.

Tijeras de titanio

Tijeras que combinan hojas de titanio para una mayor durabilidad con un corte suave y preciso. Ideales para uso doméstico, escolar o profesional, garantizan resistencia a la corrosión y un rendimiento prolongado. Con un diseño ergonómico que proporciona comodidad incluso en usos prolongados, lo que las hace perfectas para trabajos minuciosos o de uso intensivo.

ITEM	REF.	mm	mm	mm
0780041257	TS-1257	6.75"/17cm	12	144
0780041258	TS-1258	7.5"/19cm	12	144
0780041259	TS-1259	8.5"/21cm	12	144





TS-1200

Chrome-plated metal scissors

Fully metal and chrome-plated scissors, offering maximum durability and resistance. Ideal for fine, continuous cuts, they combine robustness with a sophisticated finish, making them a practical choice for professional, school or domestic use.

Tesoura metal cromada

Tesoura totalmente metálica e cromada, oferecendo máxima durabilidade e resistência. Ideal para cortes finos e contínuos, combina robustez com um acabamento sofisticado, tornando-se uma escolha prática para uso profissional, escolar ou doméstico.



TS-1201

Ciseaux métalliques chromés

Ciseaux entièrement métalliques et chromés, offrant une durabilité et une résistance maximales. Idéaux pour les coupes fines et continues, ils allient robustesse et finition sophistiquée, ce qui en fait un choix pratique pour un usage professionnel, scolaire ou domestique.



TS-1202

Tijeras metálicas cromadas

Tijeras totalmente metálicas y cromadas, que ofrecen máxima durabilidad y resistencia. Ideales para cortes finos y continuos, combinan robustez con un acabado sofisticado, lo que las convierte en una opción práctica para uso profesional, escolar o doméstico.

ITEM	REF.	mm	mm	mm
0780041200	TS-1200	6"/15cm	12	144
0780041201	TS-1201	7"/18cm	12	144
0780041202	TS-1202	8"/20cm	12	144



Eco Scissors

Scissors with sharp metal blades and pointed tips ensure clean, precise cuts in different materials. Ergonomic handle made from eco-friendly recycled plastic. Practical and sturdy scissors, ideal for the office, school or home use.

Tesoura Eco

Tesoura com lâminas de metal afiadas e ponta em bico, garante cortes limpos e precisos em diferentes materiais. Cabo ergonômico produzido em plástico ecológico reciclado. Tesoura prática e robusta, ideal para escritório, escola ou uso doméstico.



Zig-Zag Scissors

Stainless steel zigzag scissors, perfect for crafting, scrapbooking and creative decorations. Ergonomic handle made of durable plastic offers comfort and safety during use. Ideal for paper, cardstock and other thin materials.



Tesoura Zig-Zag

A tesoura com lâmina zig-zag em aço inoxidável, perfeita para trabalhos de artesanato, scrapbooking e decorações criativas. Cabo ergonômico em plástico resistente oferece conforto e segurança durante o uso. Ideal para papel, cartolina e outros materiais finos.

Ciseaux Eco

Ciseaux avec lames métalliques tranchantes et pointe effilée, garantissant des coupes nettes et précises dans différents matériaux. Manche ergonomique en plastique recyclé écologique. Ciseaux pratiques et robustes, idéaux pour le bureau, l'école ou un usage domestique.

Tijeras Eco

Tijeras con hojas metálicas afiladas y punta en forma de pico, garantizan cortes limpios y precisos en diferentes materiales. Mango ergonômico fabricado en plástico ecológico reciclado. Tijeras prácticas y resistentes, ideales para la oficina, la escuela o el uso doméstico.

Ciseaux Zig-Zag

Ciseaux à lame zigzag en acier inoxydable, parfaits pour les travaux manuels, le scrapbooking et les décorations créatives. Manche ergonomique en plastique résistant offrant confort et sécurité lors de l'utilisation. Idéaux pour le papier, le carton et autres matériaux fins.

Tijeras Zig-Zag

Tijeras con hoja en zigzag de acero inoxidable, perfectas para trabajos de manualidades, scrapbooking y decoraciones creativas. El mango ergonômico de plástico resistente ofrece comodidad y seguridad durante su uso. Ideales para papel, cartulina y otros materiales finos.

ITEM	REF.	mm	mm	mm
0780042256	TS-225	8.5"/21.5cm	12	144

ITEM	REF.	mm	mm	mm
0780048702	TS-8702	6"/15cm	12	144



X18



X9



Office cutter

High-quality office cutter with a retractable steel blade and a removable clip on the handle for safe blade break-off.

X-Acto

X-atos com lâmina em aço inoxidável, corpo em plástico ou metal, dispositivo de segurança.



6337



6335

Cutter de bureau

Cutter de haute qualité en plastique avec une lame en acier inoxydable. Système de blocage de la lame et chargement automatique.



Cortador de oficina

Para uso profesional con cuchillas en acero inoxidable de 9 o 18 mm y revestimiento en metal para una mayor duración.

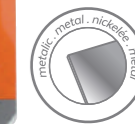

ITEM	REF.	mm	mm	mm
0780046335	6335	9mm	24	288
0780046337	6337	18mm	12	144
0780047809	X9	9mm	60	1440
0780047818	X18	18mm	12	480



18mm



9mm

Spare Blades

Spare blades of 9 or 18mm for office cutters available in plastic tubes.

Lâminas

Lâminas em aço inoxidável de 9 e 18mm comercializadas em tubo de plástico.

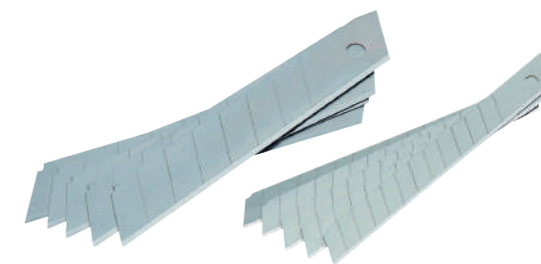

Lames

Lames pour cutters de bureau contient rolames.

Cuchillas

Cuchillas de repuesto de 9 o 18 mm para los cortadores de oficina disponibles en tubos de plástico.

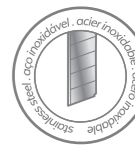



ASTM-4236



Glue stick

Glue stick, solvent free, washable and without smell. Non toxic. Glues quickly and easily.

Stick cola

Cola stick (baton) sem solventes, lavável e sem odor. Não é tóxica. Permite uniões limpas e seguras.

Bâton de colle

Bâton de colle pratique et propre sans solvant. Colle rapidement et efficacement pour une longue durée. Lavable a froid.

Pegamento en barra

Pegamento sin disolventes, lavable y sin olor. No tóxico. Permite uniones limpias y seguras.

ITEM	REF.					
0350020121	121	9gr	✓	✓	30	480
0350020122	122	21gr	✓	✓	20	320
0350020123	123	36gr	✓	✓	12	144
03500299916	121-BLT2	9gr	✓	✓	2	12
03500299915	122-BLT	21gr	✓	✓	1	12
03500299917	123-BLT	36gr	✓	✓	1	12

paper, card and others materials papel, cartão e outros materiais papier, carton et autres materiaux papel, cartón y otros materiales



White glue

White glue extra-strong solvents free and non-toxic. Universal application at school, home, office or for handicraft.

Cola branca

Cola branca extra-forte, não tóxica e sem solventes. Não inflamável.

Colle blanche

Colle blanche resistente, sans solvant et non toxique. Application universelle pour utiliser dans l'école, la maison, le bureaux et en travaux manuels.

Pegamento blanco

Pegamento blanco extrafuerte, no tóxica y sin disolventes, no inflamable.

ITEM	REF.				
0350020100	321	100g	1	24	
0350020250	322	250g	1	24	
0350020700	323	700g	1	12	
0350020006	324	6kg	1	-	

suitable for bonding paper, cardboard, wood, leather and textiles papel, madeiras, cartão, couro, tecido, borracha papier, carton, bois, cuir et tissu maderas, cartón, cuero, tejidos, goma



White glue with applicator

Water-based liquid white glue, non toxic, washable, with application tip. Ideal for handicrafts. Easy and accurate application on paper, cardboard, fabric, felt, polystyrene, leather, cork and wood.

Cola branca com aplicador

Cola branca líquida à base de água, não tóxica, lavável, com ponta de aplicação. Ideal para trabalhos manuais. Aplicação fácil e precisa, ideal para papel, cartão, tecido, esferovite, cabedal, couro, cortiça e madeira.

Colle blanche avec applicateur

Colle blanche liquide à base d'eau, non toxique, lavable, avec pointe d'application. Idéal pour travaux manuels. Application rapide et précise, indiquée pour papier, carton, tissu, feutre, polystyrène, cuir, liège et bois.

Pegamento blanco aplicador

Pegamento blanco líquido a base de agua, no tóxico, lavable, con punta de aplicación. Ideal para manualidades. De fácil aplicación y precisa sobre el papel, cartón, tela, fieltro, poliestireno, cuero, corcho y madera.

ITEM	REF.				
03500203560	035-60	60grs	✓	12	72
035002035125	035-125	125grs	✓	12	72

suitable for bonding paper, cardboard, wood, leather and textiles papel, madeiras, cartão, couro, tecido, borracha papier, carton, bois, cuir et tissu maderas, cartón, cuero, tejidos, goma



White glue with applicator

Water-based liquid white glue, non toxic, washable, with application tip. Ideal for handicrafts. Easy and accurate application on paper, cardboard, fabric, felt, polystyrene, leather, cork and wood.

Cola branca com aplicador

Cola branca líquida à base de água, não tóxica, lavável, com ponta de aplicação. Ideal para trabalhos manuais. Aplicação fácil e precisa, ideal para papel, cartão, tecido, feltro, esferovite, cabedal, couro, cortiça e madeira.

Colle blanche avec applicateur

Colle blanche liquide à base d'eau, non toxique, lavable, avec pointe d'application. Idéal pour travaux manuels. Application rapide et précise, indiquée pour papier, carton, tissu, feutre, polystyrène, cuir, liège et bois.

Pegamento blanco aplicador

Pegamento blanco líquido a base de agua, no tóxico, lavable, con punta de aplicación. Ideal para manualidades. De fácil aplicación y precisa sobre el papel, cartón, tela, fieltro, poliestireno, cuero, corcho y madera.

ITEM	REF.				
0350041000	035-60	60grs	✓	12	72
	035-125	125grs	✓	12	72

suitable for bonding paper, cardboard, wood, leather and textiles papel, madeiras, cartão, couro, tecido, borracha papier, carton, bois, cuir et tissu maderas, cartón, cuero, tejidos, goma



Universal glue

Universal transparent glue, synthetic, non toxic, removable and glues quickly. Solvent free.

Cola universal

Tubo de cola líquida sintética, transparente. Não tóxico. Removível e de secagem rápida.

Colle universelle

Colle liquide transparente, synthétique, non toxique, colle rapidement, sans solvant.

Pegamento universal

Tubo de pegamento líquido sintético, transparente. Não tóxico, extraível e de secado rápido.

ITEM	REF.	20ml	35ml	125ml
03500200201	221	20	10	-
03500200351	222	35	10	-
0350020125	223	125	5	-

paper, wood, glass, ceramic, leather and cardboard madeira, papel, cartolina, tecidos, feltro, placas EVA, cortiça entre outros. Para uso escolar, em casa ou escritório papier, carton, bois, tissu, plastiques et autres madera, papel, cartulina, tejidos, fieltro, entre otros



Super glue

Super glue with high bond strength. Soft smell and transparent color. Wide range of applications (home, office, electronics, automobile, others). For best use, surfaces must be clean and dry. Press and hold in place for 5 - 30 seconds.

Super cola

Super cola de alta resistência de união. De cheiro suave e cor transparente. Ampla gama de aplicações (casa, escritório, eletrônica, automóvel, outras). Para uma melhor utilização, as superfícies devem de estar limpas e secas. Pressionar e manter no lugar por 5 - 30 segundos.

Super colle

Super colle à haute adhérence. De douce odeur et de couleur transparente. Large gamme d'applications (maison, bureau, électronique, automobile, autres). Pour une meilleure utilisation, les surfaces doivent être propres et sèches. Appuyez et maintenez en place pendant 5 à 30 secondes.

Super pegamento

Super pegamento con alta fuerza de unión. De olor suave y color transparente. Amplia gama de aplicaciones (hogar, oficina, electrónica, automóvil, otras). Para un mejor uso, las superficies deben estar limpias y secas. Mantenga presionado en su lugar durante 5 a 30 segundos.

ITEM	REF.	3GR	12	360	720
0350042020	SG2020	3GR	12	360	720

wood, rubber, metal, ceramics, plastics, leather, glass, stone madeira, borracha, metal, cerâmica, plásticos, couro, vidro, pedra bois, caoutchouc, métal, céramique, plastiques, cuir, verre, pierre madera, caucho, metal, cerámica, plásticos, cuero, vidrio, piedra



Contact glue

Universal powerful contact adhesive, very resistant, permanently elastic, high final strength and water resistant.

Cola contacto

Cola de contacto, transparente, com bastante resistência. Graças à sua flexibilidade, mantém a elasticidade e acompanha as tensões de cada material. Resiste à água, a soluções ácidas e básicas diluídas.

Colle contact

Colle de contact, transparent, très résistant. La colle résiste à l'eau, températures hautes, à l'huile, aux acides dilués et solutions alcalines.

Pegamento de contacto

Pegamento de contacto, transparente, gracias a su flexibilidad, mantiene la elasticidad y acompaña las propiedades de cada material. Resistente al agua y a las soluciones básicas diluidas.

ITEM	REF.	50ml	1	70
0350020050	421	50ml	1	70

paper, wood, cardboard, ceramic, glass, leather, tissue, metal, cork, felt madeira, cartolina, papel, tecidos, couro, cerâmica, vidro, porcelana, mármore, metal, feltro, cortiça e palha bois, plastique, céramique, porcelaine, verre, métal, cuir, tissu, feutre et autres madera, cartulina, papel, tejidos, cuero, cerámica, vidrio, porcelana, mármol, metal, fieltro, etc



Mousse glue

Liquid glue for easy and precise applications super fast, does not wrinkle paper. Handy and clean. Solvent free.

Cola mousse

Cola líquida com aplicador, lavável e não tóxico, especialmente indicada para aplicações precisas.

Colle mousse

Colle sans solvant pour une collage propre, précis et rapide grâce à son embout applicateur.

Pegamento líquido

Pegamento líquido com aplicador, lavável e não tóxico para aplicações precisas.

ITEM	REF.	30ml	65ml	1lt	30+47
0350020066	66	30ml	1	35	
0350020088	88	65ml	1	24	
0350020011	99	1lt	1	12	
03500299912	66-BLT	30ml	1	12	

paper, card and others materials papel, cartão e cartolinas papier, carton et carte papel, cartón y cartolinas

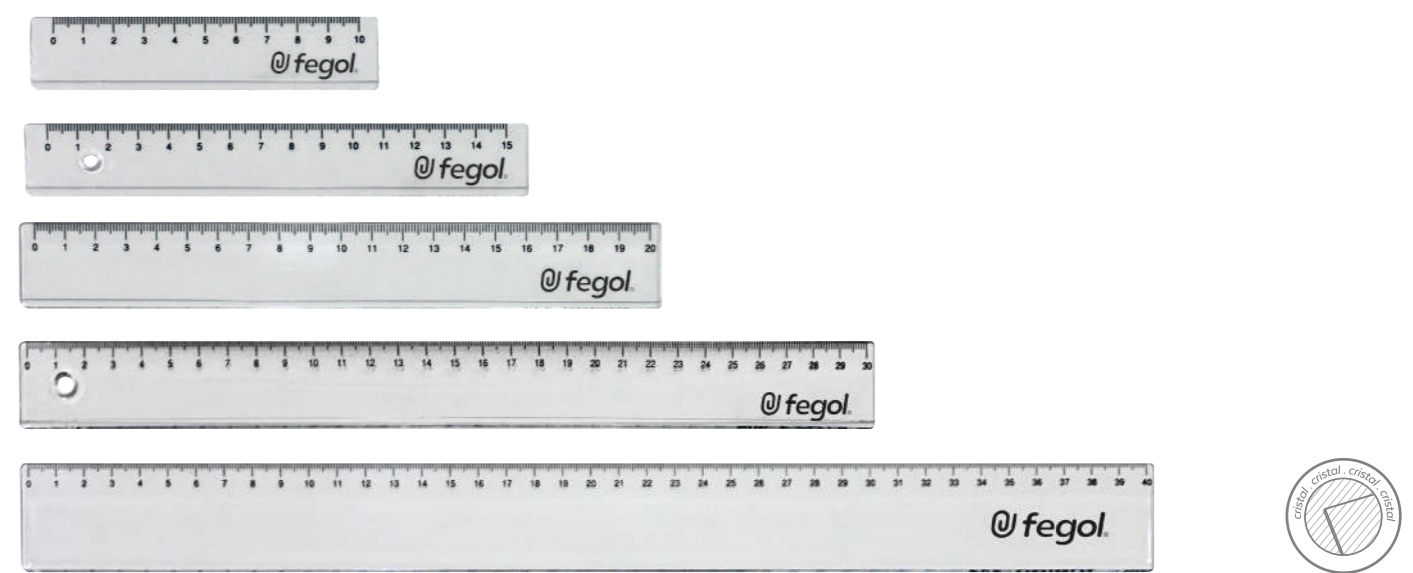

Plastic ruler

High quality polystyrene ruler with horizontal graduation and beveled edge. Graduations marked clearly in black. Thickness 2-2,5 mm. 1 mm scale.

Régua de plástico

Régua em poliestireno transparente com graduação horizontal e borda biselada. Graduações marcadas a preto. Espessura 2-2,5 mm e escala 1mm.

Règle en plastique

Règle en polystyrène de haute qualité transparente avec graduation horizontale et bord biseauté. Graduations clairement marquées en noir. Épaisseur 2-2,5 millimètres. Échelle 1 millimètres.

Regla de plástico

Regla de poliestireno transparente con graduação horizontal y borde biselado. Graduações marcadas en negro. Espesor 2-2,5mm y escala de 1mm.

ITEM	REF.	10cm	50	1200	600	400	400	200
0890021095	20-10	10cm	50	-				
0890021595	20-15	15cm	50	1200				
0890022095	20-20	20cm	50	600				
0890023095	20-30	30cm	50	400				
0890024095	20-40	40cm	50	400				
0890025095	20-50	50cm	100	200				

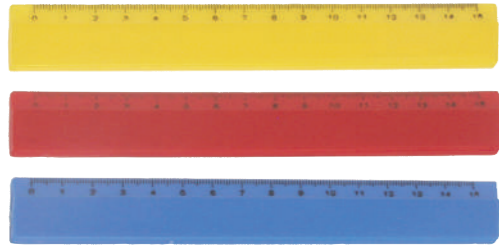

Plastic ruler

High quality polystyrene opaque ruler with horizontal graduation and beveled edge. Graduations marked clearly in black. 2-2,5mm thickness, 1mm scale.

Régua de plástico

Régua em poliestireno opaco com gradação horizontal e borda biselada. Graduações marcadas a preto. Espessura 2-2,5mm e escala 1mm.

Règle en plastique

Règle en polystyrène de haute qualité opaque avec graduation horizontale et bord biseauté. Graduations clairement marquées en noir. Épaisseur 2-2,5mm. Échelle 1 millimètres.

Regla de plástico

Regla de poliestireno opaco con graduación horizontal y borde biselado. Graduações marcadas en negro. Espesor 2-2,5mm y escala de 1mm.

ITEM	REF.	mm	mm	mm	mm
0890021599	-	15cm	200	1200	

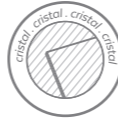
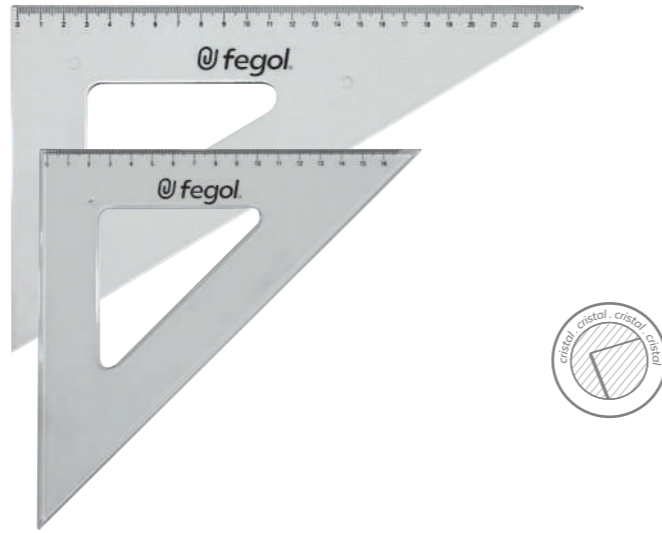

Square

Polystyrene square with lateral graduation and beveled edge. Graduations clearly marked in black. 2-2,5mm thickness, 1mm scale.

Esquadro

Esquadro em poliestireno transparente com gradação lateral, arestas biseladas e plástico cristalino. Espessura 2-2,5mm e escala de 1mm.

Équerre

Équerre en polystyrène transparente avec graduation laterale et bord biseauté, graduations clairement marquées en noir, épaisseur 2-2,5mm et échelle 1 millimètre.

Escuadra y cartabón

Escuadra y cartabón en poliestireno transparente con graduación lateral, aristas biseladas y plástico cristalino, espesor 2-2,5mm y escala de 1mm.

ITEM	REF.	mm	mm	mm	mm
0910024521	10-14	e-14cm	45°/21cm	50	600
0910024526	10-17	e-17cm	45°/26cm	100	200
0910024532	10-21	e-21cm	45°/32cm	100	200
0910026021	10-20	e-21cm	60°/21cm	100	600
0910026026	10-26	e-26cm	60°/26cm	100	200
0910026032	10-29	e-29cm	60°/32cm	100	200

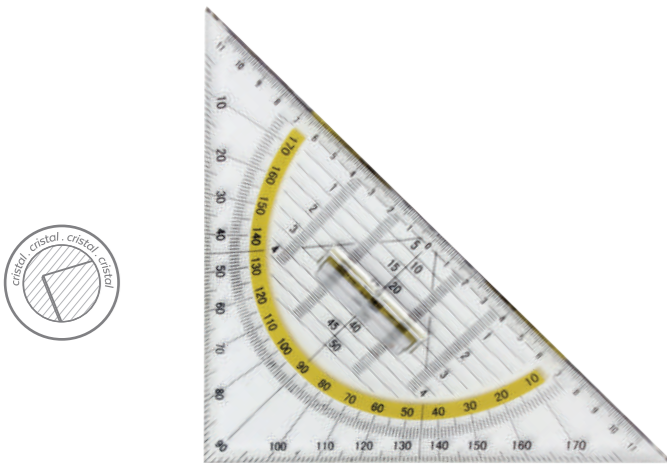

Geometric square

Transparent technical square with handle, scales in millimeters, colored mark to trace parallels and verticals, beveled edges and reinforced corners.

Esquadro geométrico

Esquadro para desenho técnico transparente com pega, gradação fina e exata, numeração em sentido contrário, divisão angular, marcações coloridas para traçar paralelas e verticais, escalas em milímetros, arestas biseladas e cantos reforçados.

Équerre géométrique

Équerre géométrique avec poignée, bandes gradués et biseautés, les angles indiqués dans les deux sens, grilles de lignes parallèles et verticales coloris en millimètres, coins renforcés.

Escuadra geométrica

Escuadra de dibujo técnico, transparente, mango resistente, escala de graduación opuesta con fondo en color, cantos biselados y botones para dibujar con tinta.

ITEM	REF.	mm	mm	mm
0910020222	222	25 cm	50	300

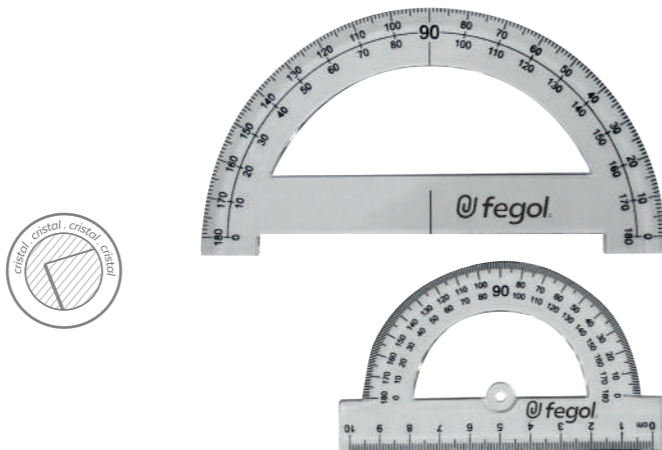

Protractor

Polystyrene transparent protractor consisting of a divided circular scale (180°), marked in angles spaced out regularly as a ruler. 1mm scale.

Transferidor

Transferidor em plástico transparente, composto por uma escala circular dividida e marcada em ângulos espaçados regularmente, como uma régua.

Rapporteur

Rapporteur en polystyrène avec une scale circulaire (180°) divisée et marquée en angles espacés régulièrement comme une règle. Échelle de 1 millimètre.

Semicírculo

Instrumento de plástico transparente compuesto por una escala circular dividida y marcada en ángulos espaciados regularmente como una regla. Disponible con base de 10 y 15 centímetros en los ángulos de 180°.

ITEM	REF.	mm	mm	mm
0900021801595	30-15	180°/15cm	100	600
0900021809595	30-10	180°/10cm	50	1200



Compass

Matte nickel plated gear head compass, hinged needle and lead legs. Ergonomic handhold. Anti-shock plastic box.

Compasso

Compassos universais niquelados com ajuste fácil e rápido, zonas de manuseamento confortáveis e bastante ergonómicas.

Compas

Compas à pièces interchangeables en métal nickelé, branche à articulation. Creux de prehension confortable. Boîte en plastique très résistant.

Compás

Compás universal con cuerpo y herrajes de bronce acabado niquelado satinado, ajuste fácil y rápido, zonas muy comfortable y manejo ergonómico.

ITEM	REF.	mm	mm	mm	mm			
0400022011	2011	> 320mm	L130mm	compass, protection	compasso, protecção	compas, protection	compás, protección	24
0400024011	3011	> 320mm	L130mm	compass, lead tube	compasso, tubo minas	compas, tube de mines	compás, tubo de minas	50
0400045011	5011	> 320mm	L130mm	compass, safety needle, lead tube, lead eraser	compasso, agulha segurança, tubo de minas, tira-linhas	compas, aiguille de sécurité, tube de mines, effaceur	compás, aguja de seguridad, tubo de minas, sacapuntas	40
0400046011	6011	> 320mm	L130mm	compass, lead tube, universal adapter	compasso, tubo minas, adaptador universal	compas, tube de mines, adaptateur universel	compás, tubo de minas, adaptador universal	40
0400047011	SAFEGUARD	> 320mm	L130mm	compass, lead tube, tip protection, universal adapter	compasso, tubo minas, proteção ponta, adaptador universal	compas, tube de mines, protection de pointe, adaptateur universel	compás, tubo de minas, protección de punta, adaptador universal	30



Fastrack Micrometric Compass

Quick-adjust micrometric compass with comfort mechanism. Precise adjustment thanks to the central knurled wheel. Synchronised opening and closing with an additional extension. With 4 pieces.

Compasso Micrométrico Fastrack

Compasso micrométrico de ajuste rápido com mecanismo de confort. Ajuste preciso graças à roda recartilhada central. Abertura e fecho sincronizado com uma extensão adicional. Com 4 peças.

Compas micrométrica Fastrack

Compas micrométrica à réglage rapide avec mécanisme confort. Réglage précis grâce à la molette centrale. Ouverture et fermeture synchronisées avec une extension supplémentaire. 4 pièces.

Compas micrométrico Fastrack

Compás micrométrico de ajuste rápido con mecanismo de confort. Ajuste preciso gracias a la rueda central moleteada. Apertura y cierre sincronizados con una extensión adicional. Con 4 piezas.

ITEM	REF.	mm
0400048011	FASTRACK	96

LEARNING

APRENDER

APPRENDRE

APRENDER



Notebook Flex PP

Stapled notebook with sheets of high quality paper 90g/m2 no margins and round corners. Flexible cover allows book to open 180° without deform or damage.

Caderno Flex PP

Caderno agrafado com folhas em papel branco de 90g/m2, sem margens e cantos arredondados. Capa de plástico muito resistente e flexível. Abertura total a 180° sem deformar.

Cahier PP Flex

Cahier agrafé avec feuilles en papier blanc de 90g/m2 sans marges et coins arrondis. Couverture en plastique très résistante et flexible. Ouverture totale a 180° sans déformer.

Cuaderno Flex PP

Cuadernos grapado en papel blanco de 90g/m2, sin margens y cantos redondeados. Tapa de plástico muy resistente y flexible. Abertura total a 180° sin deformar.

ITEM	REF.								
24600414481	FLEX-A4-P	A4	90	48	✓			10	30
24600414482	FLEX-A4-X	A4	90	48		✓		10	30

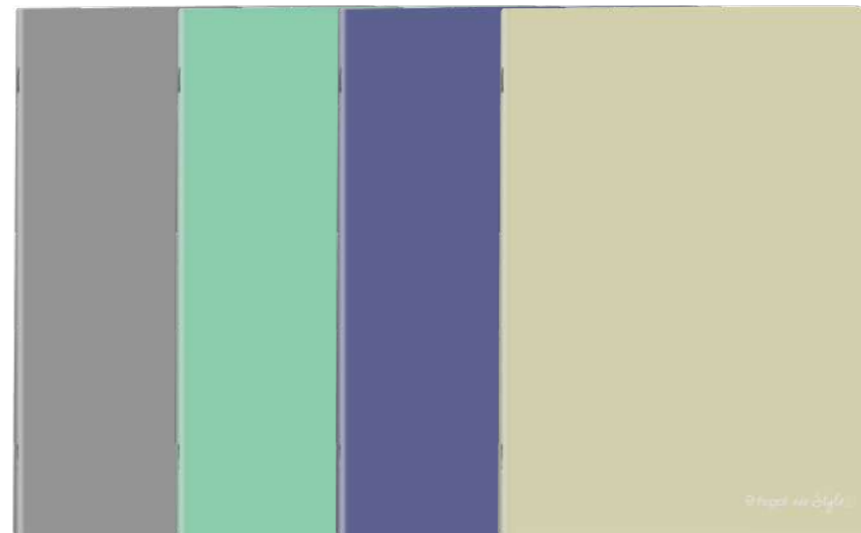

neo:Style Pastel stapled notebook

Stapled notebook with 60 blank 80g/m2 sheets, margins and rounded corners. Cover in plastic card, printed in 5 assorted colors.

Caderno agrafado neo:Style Pastel

Caderno agrafado de 60 folhas em papel branco de 80g/m2, com margens e cantos arredondados. Capa em cartão plastificado, impresso em 5 cores sortidas.

Cahier agrafé neo:Style Pastel

Cahier agrafé avec 60 feuilles de papier blanc 80g/m2, avec des coins et coins arrondis. Couverture en carton plastique imprimé en 5 couleurs assorties.

Cuaderno grapado neo:Style Pastel

Cuaderno grapado con 60 hojas de papel blanco con 80g/m2, con márgens y esquinas redondeadas. Cubierta en cartón plástico, impresso en 5 colores surtidos.

ITEM	REF.								
24600414601	CA-NEOSTYLEA4-P	A4	80	60	✓			10	30
24600414602	CA-NEOSTYLEA4-X	A4	80	60		✓		10	30
24600414603	CA-NEOSTYLEA4-L	A4	80	60		✓		10	30



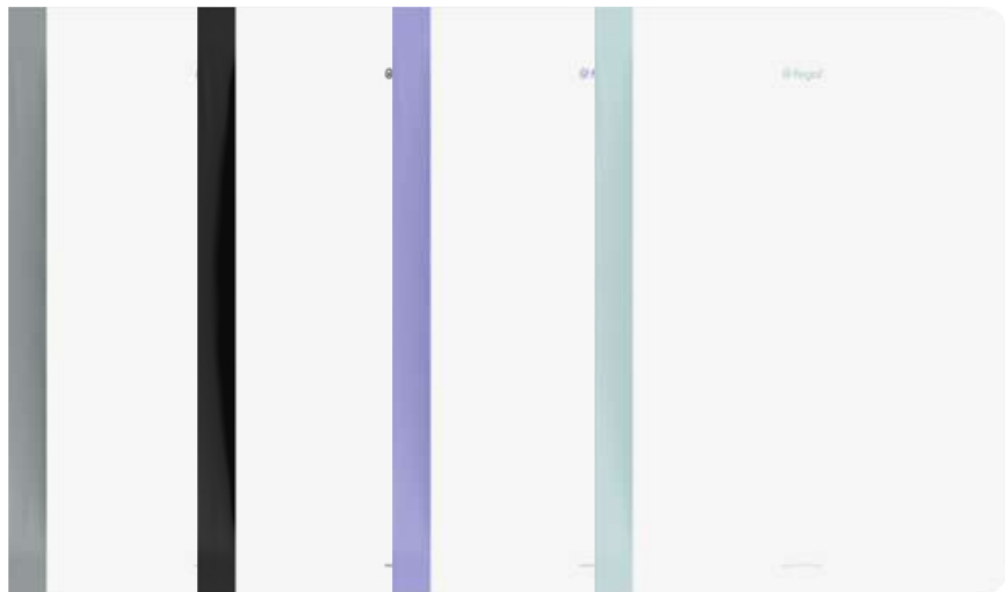

Notebook Half

Stapled notebook with sheets of high quality paper 90g/m2 with margins and round corners. Flexible cover allows book to open 180° without deform or damage. With matt and glossy finish.

Caderno Half

Caderno agrafado com folhas em papel branco de 90g/m2, com margens e cantos arredondados. Capa resistente e flexível. Abertura total a 180° sem deformar. Com acabamento matte e brilho.

Cahier Half

Cahier agrafé avec feuilles en papier blanc de 90g/m2 avec marges et coins arrondis. Couverture résistante et flexible. Ouverture totale a 180° sans déformer. Avec finition mate et brillante.

Cuaderno Half

Cuadernos grapado en papel blanco de 90g/m2, con margens y cantos redondeados. Tapa resistente y flexible. Abertura total a 180° sin deformar. Con acabado mate y brillante.

ITEM	REF.	A4	90	48	✓	10	30
24600424201	CAG-HALFA4P						

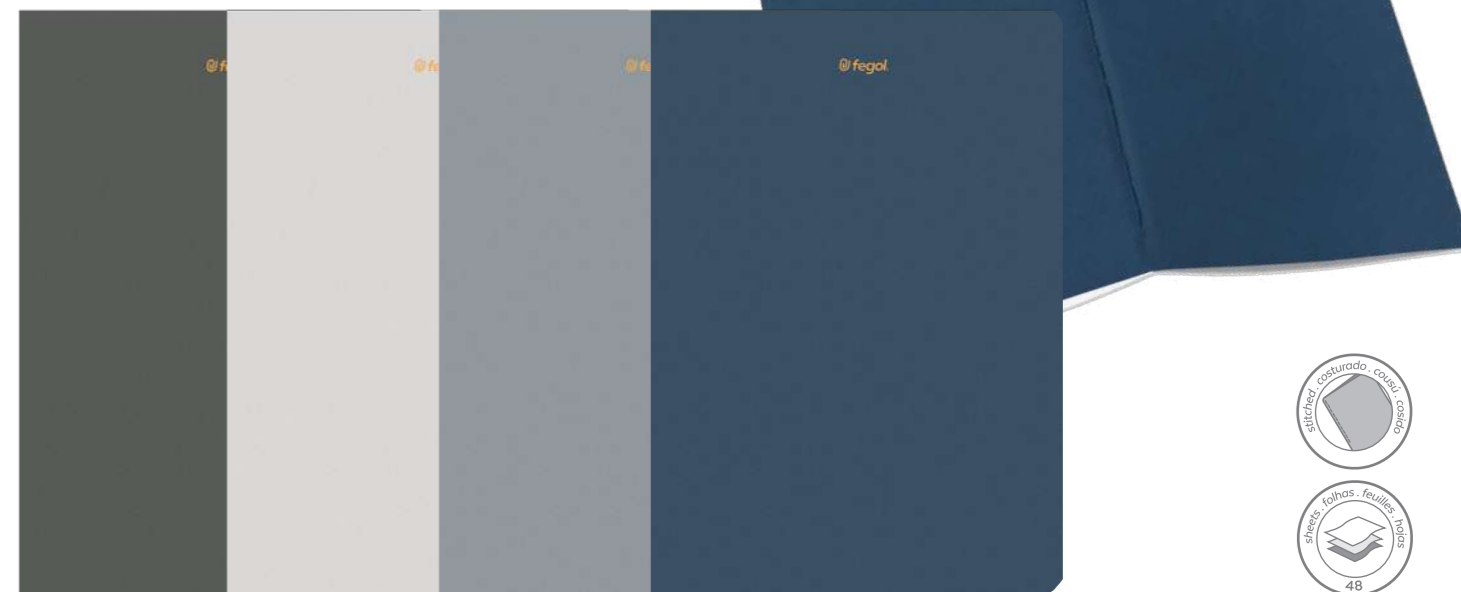

Notebook Palette

Sewn notebook with 90g/m2 white paper pages, without margins and with rounded corners. Sturdy, flexible cover. Full 180° opening without deformation. Matt finish.

Caderno Palette

Caderno cosido com folhas em papel branco de 90g/m2, sem margens e com cantos arredondados. Capa resistente e flexível. Abertura total a 180° sem deformar. Com acabamento matte.

Cahier Palette

Cahier cousu avec pages en papier blanc 90g/m2, sans marges et avec coins arrondis. Couverture robuste et souple. Ouverture totale à 180° sans déformation. Finition mate.

Cuaderno Palette

Cuaderno cosido con páginas de papel blanco de 90 g/m2, sin márgenes y con esquinas redondeadas. Cubierta resistente y flexible. Abertura total de 180° sin deformación. Acabado mate.

ITEM	REF.	A4	90	48	✓	8	48
246004461881	-						

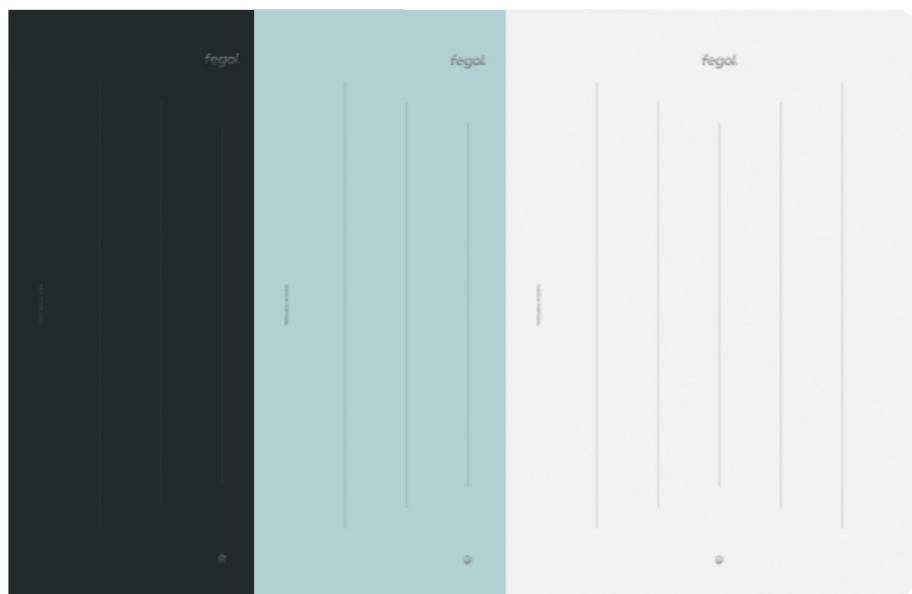

Notebook (re)mind

Stapled notebook with sheets of high quality paper 80g/m2 with margins and round corners. With matt and glossy finish.

Caderno (re)mind

Caderno agrafado com folhas em papel branco de 80g/m2, com margens e cantos arredondados. Capa de plástico muito resistente e flexível. Com acabamento matte e brilho.

Cahier (re)mind

Cahier agrafé avec feuilles en papier blanc de 80g/m2 avec marges et coins arrondis. Couverture en plastique très résistante et flexible. Avec finition mate et brillante.

Cuaderno (re)mind

Cuadernos grapado en papel blanco de 80g/m2, con margens y cantos redondeados. Tapa muy resistente y flexible. Con acabado mate y brillante.

ITEM	REF.	A4	80	48	✓	10	30
24600424301	CAG-MINDA4P						



Colors cover wirebound notebook

Silicon wirebound notebook with 70g/m2 sheets, double margin with round corners. Cover in plastified cardboard.

Caderno espiral capa Colors

Caderno com espiral em silicone, folhas em papel de 70g/m2, com margem dupla, cantos arredondados.

Cahier à spirales de couverture colorée

Cahier à reliure en silicon avec feuilles de 70g/m2 et coin arrondis. Couverture en carton plastifié imprimé.

Cuaderno espiral tapa Colors

Cuaderno espiral de silicone, papel de 70g/m2 con margen doble con cantos redondeados. Tapa de cartulina plastificado impreso en colores.

ITEM	REF.	A4	70	80	✓	10	40
246002014801	COLORS	A4	70	80			
246002014802	COLORS	A4	70	80	✓		
246002014803	COLORS	A4	70	80		✓	
246002015801	COLORS	A5	70	80	✓		
246002015802	COLORS	A5	70	80		✓	
246002015803	COLORS	A5	70	80			✓

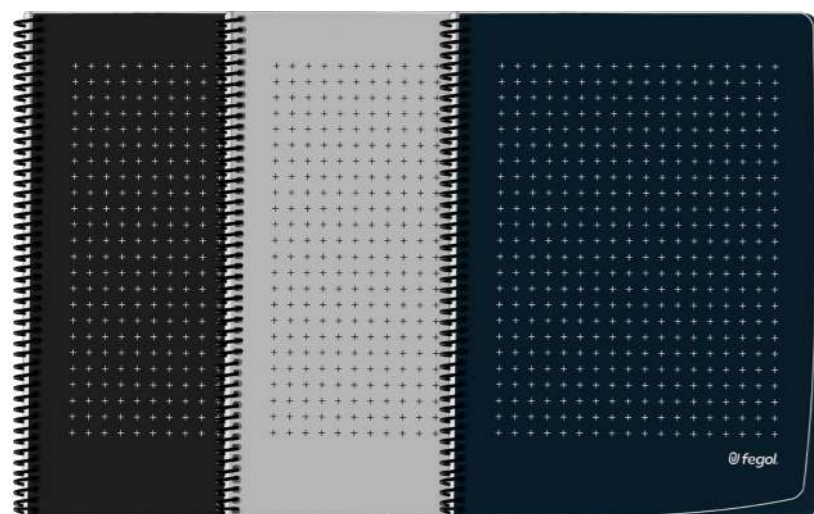

Lite PP cover wirebound notebook

Silicon wirebound notebook with 80g/m2 sheets, double margin with round corners. Cover in plastified cardboard and PP cover.

Caderno espiral capa PP Lite

Caderno com espiral em silicone, folhas em papel de 80g/m2, com margem dupla, cantos arredondados e capa PP.

Cahier à spirales de couverture PP Lite

Cahier à reliure en silicon avec feuilles de 80g/m2 et coin arrondis. Couverture en carton plastifié imprimé et PP.

Cuaderno PP espiral tapa Lite

Cuaderno espiral de silicon, papel de 80g/m2 con margen doble con cantos redondeados. Tapa de cartulina plastificado impreso en colores e PP.



ITEM	REF.	g/m2	80	80	✓	10	40
24600423103	COLORS	A4	80	80	✓	10	40

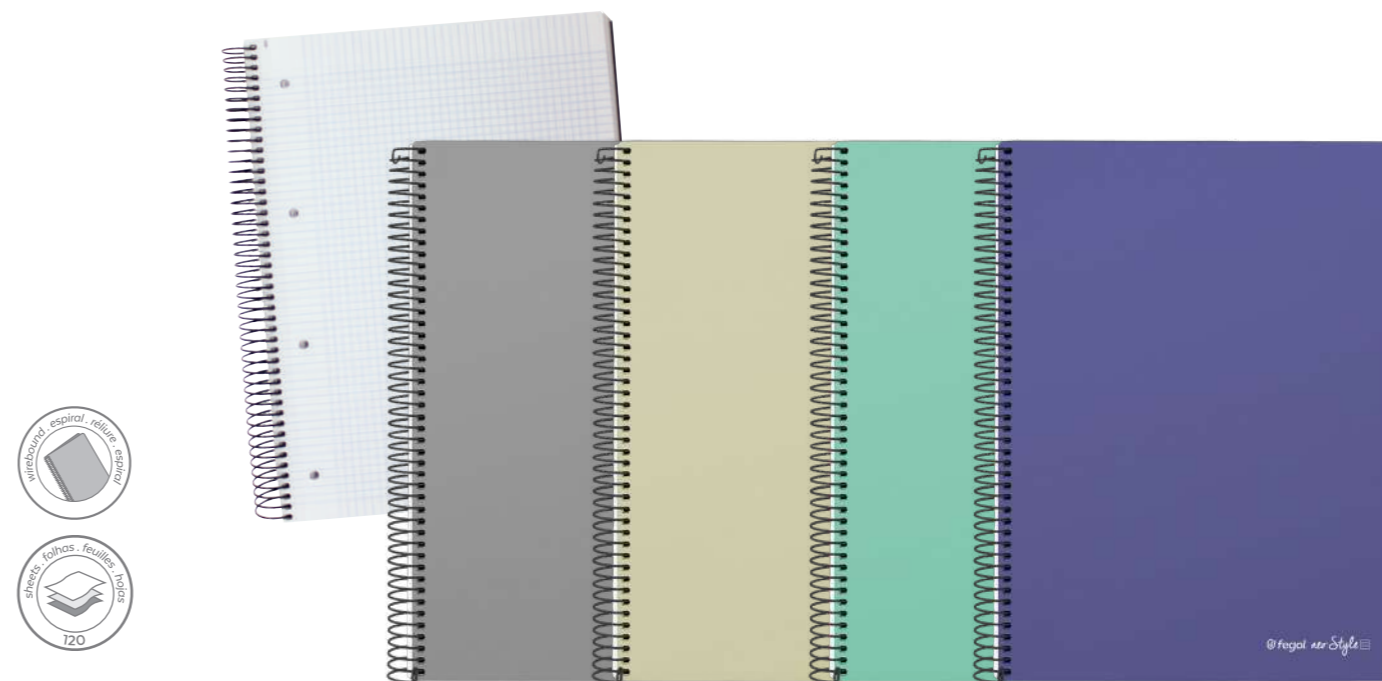

neo:Style hard cover notebook

Wirebound notebook with rigid hard cover in coated card, 120 sheets of 80g/m2. Available in A4 and A5 format.

Caderno capa dura neo:Style

Caderno de capa extra dura com espiral simples, folhas em papel de 80g/m2. Disponível nos formatos A4 e A5.

Cahier couverture carte rigide neo:Style

Cahier à spirales avec couverture en carte rigide fourré en papier imprimé plastifié. Feuilles de 80g/m2. Disponible en A4 et A5 formats.

Cuaderno tapa dura neo:Style

Cuaderno de tapa dura con espiral simples, papel de 80g/m2. Disponible en los tamaños A4 y A5.



ITEM	REF.	A4	80	120	✓	5	10
246004241201	CE-NEOA4120P	A4	80	120	✓	5	10
246004241202	CE-NEOA4120X	A4	80	120	✓	5	10



Trip hard cover notebook

Wirebound notebook with rigid hard cover in coated card, 80 sheets of 90g/m2. Available in A4 and B5 format.

Caderno capa dura Trip

Caderno encadernado com capa dura rígida em cartão revestido, 80 folhas de 90g/m2. Disponível em formato A4 e B5.

Cahier couverture carte rigide Trip

Cahier relié avec couverture rigide en carton couché, 80 feuilles de 90g/m2. Disponible en format A4 et B5.

Cuaderno tapa dura Trip

Cuaderno encuadernado con tapa dura rígida de cartón estucado, 80 hojas de 90 g/m2. Disponible en formato A4 y B5.



ITEM	REF.	A4	90	80	✓	6	24
246004461911	461911	A4	90	80	✓	6	24
246004461942	461942	B5	90	80	✓	6	24



Notebook Spiral Soft PP

Fegol Soft flexible spiral notebook with durable polypropylene cover, ideal for everyday use at school or in the office. The silicone spiral binding ensures practical and comfortable opening, with no risk of breakage.

Caderno Spiral Soft PP

Caderno com espiral flexível Soft da Fegol com capa em polipropileno resistente, ideal para o uso diário na escola ou escritório. A lombada espiral em silicone garante uma abertura prática e confortável, sem riscos de quebra.

Cahier à spirales Soft PP

Cahier à spirale souple Soft de Fegol avec couverture en polypropylène résistante, idéal pour une utilisation quotidienne à l'école ou au bureau. La spirale en silicone garantit une ouverture pratique et confortable, sans risque de rupture.

Cuaderno espiral Soft PP

Cuaderno con espiral flexible Soft de Fegol con cubierta de polipropileno resistente, ideal para el uso diario en la escuela o la oficina. El lomo de espiral de silicona garantiza una apertura práctica y cómoda, sin riesgo de rotura.



ITEM	REF.	A4	90	60	✓	10	40
246004461980	461980	A4	90	60	✓	10	40
246004462161	462161	A4	90	60	✓	10	40

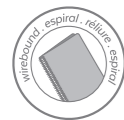
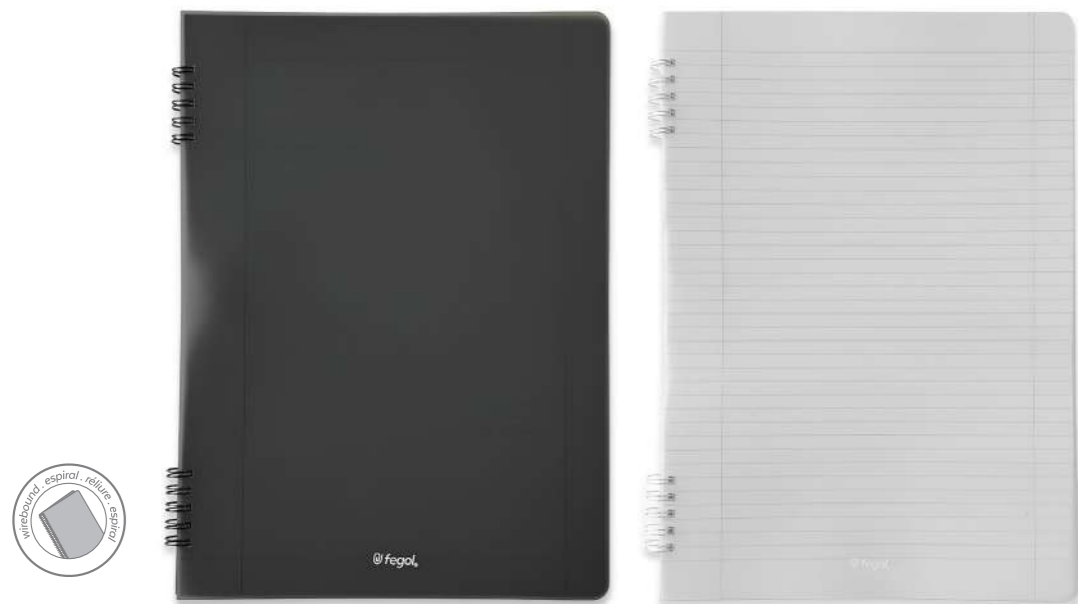

Notebook Spiral Soft Touch PP

Notebook with a soft-touch PP Soft Touch cover and modern finish, combining strength and elegance in a versatile A4 format for school, office or professional use. With double spiral binding that allows full opening and greater comfort in daily use.

Caderno Spiral Soft Touch PP

Caderno com capa PP Soft Touch de toque suave e acabamento moderno, alia resistência e elegância num formato A4 versátil para escola, escritório ou uso profissional. Com espiral dupla que permite abertura total e maior conforto na utilização diária.

Cahier à spirales Soft Touch PP

Cahier avec couverture PP Soft Touch au toucher doux et à la finition moderne, alliant résistance et élégance dans un format A4 polyvalent pour l'école, le bureau ou un usage professionnel. Avec double spirale permettant une ouverture totale et un plus grand confort d'utilisation au quotidien.

Cuaderno espiral Soft Touch PP

Cuaderno con cubierta PP Soft Touch de tacto suave y acabado moderno, que combina resistencia y elegancia en un formato A4 versátil para la escuela, la oficina o el uso profesional. Con espiral doble que permite una apertura total y mayor comodidad en el uso diario.

ITEM	REF.	A4	g/m2	80	✓	8	32
246004461980	461980						

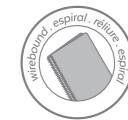

Multiclass hard cover notebook

Wirebound notebook with rigid hard cover in coated card, microperforated sheets of 70g/m2, punched with 4 holes, double margins and header. Also includes 5 bands of different colors (4 ruled sheets + 1 squared sheets) and an inside pocket, in the first page, like envelopes with a grid.

Caderno capa dura Multiclass

Caderno de capa extra dura com espiral simples, folhas em papel de 70g/m2, microperfuradas com iniciador de corte e cabeçalho. O caderno inicia com um separador com horário e uma bolsa. Dispõe de 5 bandas de cor com 4 grupos de folhas pautadas e 1 xadrez.

Cahier couverture carte rigide Multiclass

Cahier à spirales avec couverture en carte rigide fourré en papier imprimé plastifié brillant. Feuilles de 70g/m2 microperforées avec 4 trous, marges à gauche et à droite, en-tête et 5 sections de couleur (4 lignées et 1 quadrillées).

Cuaderno tapa extra dura Multiclass

Cuaderno de tapa extra dura com espiral simple, papel de 70g/m2, microperforadas com iniciador de corte. El cuaderno inicia con un separador con horario y una bolsa portadocumentos. Dispone de 5 bandas de color, 4 grupos de hojas de rayas y 1 de cuadros.

ITEM	REF.	A4	g/m2	120	✓	5	15
246002412070	MULTICLASS						

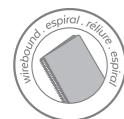

Class Premium hard cover notebook

Wirebound notebook with rigid hard cover in coated card, 160 microperforated sheets of 70g/m2, punched with 4 holes, double margins and header.

Caderno capa dura Class Premium

Caderno de capa extra dura com espiral simples, folhas em papel de 70g/m2, microperfuradas com iniciador de corte e cabeçalho.

Cahier couverture carte rigide Class Premium

Cahier à spirales avec couverture en carte rigide fourré en papier imprimé plastifié brillant. Feuilles de 70g/m2 microperforées avec 4 trous et marges à gauche et à droite.

Cuaderno tapa dura Class Premium

Cuaderno de tapa dura com espiral simples, papel de 70g/m2, microperforadas com iniciador de corte e cabeçalho.

ITEM	REF.	A4	g/m2	80	✓	6	12
24600448001	246117						
24600448002	246120						



Stone Paper notebook

Recycled stone paper pad, offers surprisingly smooth writing, water and tear resistant, ideal for those who demand more than just a simple notebook. With a sturdy double spiral binding, it adapts to everyday professional, academic or creative use.

Bloco notas Papel Pedra

Bloco em papel de pedra reciclada, oferece uma escrita surpreendentemente suave, resistente à água e a rasgos, ideal para quem exige mais do que um simples caderno. Com espiral dupla resistente, adapta-se ao dia a dia profissional, académico ou criativo.

Bloc-notes Papier Pierre

Bloc en papier recyclé, offre une écriture étonnamment douce, résistante à l'eau et aux déchirures, idéal pour ceux qui exigent plus qu'un simple cahier. Avec une double spirale résistante, il s'adapte à la vie professionnelle, académique ou créative quotidienne.

Bloc de notas Papel Pedra

Bloc de papel de pedra reciclada, ofrece una escritura sorprendentemente suave, resistente al agua y a los desgarros, ideal para quienes exigen más que un simple cuaderno. Con doble espiral resistente, se adapta al día a día profesional, académico o creativo.

ITEM	REF.	A5	g/m2	120	60	✓	6	24
246004462178	CE-STONE							



For All PP cover notebook

PP cover notebook with double spiral, 90g/m² paper pages. It has 5 coloured PP dividers with document pockets.

Caderno capa PP For All

Caderno de capa PP com espiral dupla, folhas em papel de 90g/m². Dispõe de 5 separadores em PP de cor com bolsos para documentos.

Cahier couverture carte PP For All

Cahier à couverture en PP avec double spirale, pages en papier 90g/m². Il comporte 5 intercalaires en PP de couleur avec pochettes pour documents.

Cuaderno tapa PP For All

Cuaderno de tapas de PP con doble espiral, hojas de papel de 90 g/m². Dispone de 5 separadores de PP de colores con bolsillos para documentos.

ITEM	REF.							
246004461317	461317	A4	90	120	✓	-	-	20



Black cover notebook

Stapled notebook with printed black cardboard cover, sheets of high quality paper 60/80g/m², double margin and round corners.

Caderno capa preta

Caderno agrafado com folhas em papel branco de 60/80g/m², margens e cantos arredondados. Capa em cartolina preta impressa.



School Notebook

Stapled A5 notebook with 60g/m² blank sheets and 2 colors printed cover of 80g/m².

Sebenta

Cadernos agrafados com folhas de papel liso 60g/m², no formato A5 e capa impressa a 2 cores em papel de 80g/m².

Cahier de couverture noir

Cahier de notes agrafé avec couverture de carton imprimé en noir, feuilles avec marges en papier de qualité de 60/80g/m² et coins arrondis.

Cuadernos grapado tapa negra

Cuaderno grapado en papel blanco de 60/80g/m², con márgens e cantos redondeados. Tapa en cartulina negra impressa.

ITEM	REF.							
246002024801	CA-BLACKA460-P	A4	60	80	✓			10 30
246002024802	CA-BLACKA460-X	A4	60	80		✓		10 30
246002024803	CA-BLACKA460-L	A4	60	80			✓	10 30
246002025801	CA-BLACKA560-P	A5	60	80	✓			10 60
246002025802	CA-BLACKA560-X	A5	60	80		✓		10 60
246002025803	CA-BLACKA560-L	A5	60	80			✓	10 60
246002024801	CA-BLACKA480-P	A4	80	80	✓			10 30
246002024802	CA-BLACKA480-X	A4	80	80		✓		10 30
246002024803	CA-BLACKA480-L	A4	80	80			✓	10 30
246002025801	CA-BLACKA580-P	A5	80	80	✓			10 60
246002025802	CA-BLACKA580-X	A5	80	80		✓		10 60
246002025603	CA-BLACKA580-L	A5	80	80			✓	10 60

ITEM	REF.							
2490010616	10616	A5	60	40	✓			10 100
2490010617	10617	A5	60	60	✓			10 60
2490010618	10618	A5	60	80	✓			10 60



Music notebook

Stapled notebook with printed cardboard cover specially conceived to be used in music classes, sheets with musical staff printed and lines to write musical notes.

Caderno de música

Caderno escolar de música, agrafado, com capa em cartolina impressa com verniz. Interior em folhas com pentagrama impresso e linhas para escrever algumas notas musicais.

Cahier de musique

Cahier agrafé avec couverture en carton imprimé, spécialement conçu pour être utilisé dans les classes de musique. Feuilles avec la partition musicale imprimée et lignes pour écrire notes de musique.

Cuaderno de música

Cuaderno escolar de música, grafado, con tapa en cartolina impressa. Hojas con pentagrama impresso y líneas para escribir notas musicales.



Hardcover music notebook

Music notebook with double spiral binding and clearly defined staves on high-quality paper.

Caderno de música capa dura

Caderno de música, com espiral dupla e pentagramas bem definidos em papel de alta qualidade.

Cahier de musique à couverture rigide

Cahier de musique, avec double spirale et portées bien définies sur papier de haute qualité.

Cuaderno de música con tapa dura

Cuaderno de música, con doble espiral y pentagramas bien definidos en papel de alta calidad.

ITEM	REF.							
2460020420	MUSICA	A4	60	20	✓	✓		20 100
2460020520	MUSICA	A5	60	20	✓	✓		20 200

ITEM	REF.					
2460044200	MUSICA ESPIRAL	A4	80	50	✓	



Notebook cover Protectors

Polypropylene transparent folder with 2 inside flaps to prevent notebooks from falling. Conceived to bind notebooks in A4 and A5 format.

Bolsa protege cadernos

Bolsa de arquivo em polipropileno transparente e 2 abas laterais concebida para encadernar e proteger cadernos no formato A4 e A5.

Couverture protection pour cahiers

Chemise en polypropylène transparent avec 2 rabats pour empêcher les cahiers de tomber. Conçu pour protéger les cahiers du format A4 et A5.

Forra cuadernos

Funda en polipropileno transparente, con 2 abas laterales, diseñado para proteger cuadernos no formato A4 y A5.

ITEM	REF.					
0740020004	-	A4	430x300mm	120	5	500
0740020005	-	A5	215x148mm	120	5	500

2 Lines school notebook

Stapled notebook with 20 ruled sheets with double lines. Specially conceived to be used in the first years of school to improve handwriting. Printed cardboard cover.

Caderno 2 linhas

Caderno agrafado de 20 folhas em papel branco, com 2 linhas, pautado e com margens. Ideal para utilizar no primeiro ano escolar para aprender a escrever ou melhorar a caligrafia. Capa em cartolina colorida impressa.

Cahier 2 lignes

Cahier agrafé avec 20 feuilles de lignes doubles. Spécialement conçu pour être utilisé dans les premières années d'école pour améliorer la calligraphie. Couverture en carton imprimé.

Cuaderno 2 rayas

Cuaderno grapado con 20 hojas rayadas con líneas dobles. Específicamente concebido a utilizarse en los primeros años de la escuela para mejorar la escritura a mano. Cubierta de cartón imprimido.

ITEM	REF.						
246002599202	-	A5	60	20	✓	25	250



4 holes Pad

Notebook glued at the top. 60g/m2 white paper sheets with margins and 4 holes. Printed front cover.

Bloco 4 furos

Bloco de apontamentos com folhas em papel branco de 60g/m2, coladas no topo, perfuradas na lateral esquerda (4 furos) e marginadas.

Bloc 4 trous

Bloc de bureau collé en tête avec feuilles de papier blanc de 60g/m2, marges et 4 trous. Couverture imprimée.

Bloc 4 taladros

Bloc de notas con hojas en papel blanco de 60g/m2, pegadas en el topo, perforadas na lateral izquierda (4 taladros) y con margens.

ITEM	REF.	A4	60	80	10	30
2460024480601	-	A4	60	80	10	30
2460024480602	-	A4	60	80	10	30
2460024480603	-	A4	60	80	10	30



Lite Ringbinder with elastic band

School ring binder with thin spine, 4 rings and an elastic band closure. Paper refill and dividers included. Available in 3 colours.

Capa escolar com elástico Lite

Capa escolar lombada estreita, 4 argolas e elástico. Inclui recarga de folhas e separadores. Disponível em 3 cores.

Classeur scolaire à élastique Lite

Classeur scolaire, mince, 4 anneaux et un élastique. Contient feuilles de recharge et des intercalaires. Disponible en 3 couleurs.

Carpeta escolar con elástico Lite

Carpeta escolar estrecha, 4 anillas y una goma. Incluye recarga de hojas y separadores. 3 colores disponibles.

ITEM	REF.	A4	4	1	10
24700423101	LITE-CE-A4R	A4	4	1	10



Refill paper

100 sheets, 100g/m2 white paper with 4 holes, margins and round corners.

Recarga folhas

100 folhas em papel branco de 100g/m2 com 4 furos, marginadas e canteadas.

Feuilles de recharge

Recharge de 100 feuilles de 100g/m2 avec 4 trous, marges et coins arrondis.

Recambio de bloc

100 folhas en papel blanco de 100g/m2 con 4 taladros, marginadas e canteadas.

ITEM	REF.	A4	100	100	15	1080
24600241001	25-P	A4	100	100	15	1080
24600241002	25-P	A4	100	100	15	1080
24600241003	25-P	A4	100	100	15	1080



(re)mind Ringbinder with elastic band

School ring binder with thin spine, 4 rings and an elastic band closure. Paper refill and dividers included. Available in 3 colours. With matt and glossy finish.

Capa escolar com elástico (re)mind

Capa escolar lombada estreita, 4 argolas e elástico. Inclui recarga de folhas e separadores. Disponível em 3 cores. Com acabamento matte e brilhante.

Classeur scolaire à élastique (re)mind

Classeur scolaire, mince, 4 anneaux et un élastique. Contient feuilles de recharge et des intercalaires. Disponible en 3 couleurs. Avec finition mate et brillante.

Carpeta escolar con elástico (re)mind

Carpeta escolar estrecha, 4 anillas y una goma. Incluye recarga de hojas y separadores. 3 colores disponibles. Con acabado mate y brillante.

ITEM	REF.	A4	4	1	10
24700424301	MIND-CE-A4R	A4	4	1	10





Project box with elastic band

Project box with 4cm spine and vertical elastic. Available in 5 colors.

Caixa projectos com elástico

Caixa projectos lombada 4cm e elástico na vertical. Disponível em 5 cores.

Boîte de projets avec bande élastique

Boîte de projet avec 4 cm dos et élastique vertical. Disponible en 5 couleurs.

Caja proyectos con elástico

Caja de proyecto con 4 cm de espina y elástico vertical. Disponible en 5 colores.

ITEM	REF.					
24800224804	248-04	A3	315x425x40		1	6



Extendable Playful Case

Soft, stretchable silicone case. Dual use. Can also be used as a desk stand.

Estojo Playful Extensível

Estojo de silicone macio e extensível. Com uso duplo. Serve também como suporte de secretária.

Mallette extensible Playful

Étui en silicone souple et extensible. Double usage. Peut également être utilisé comme support de bureau.

Estuche extensible Playful

Funda de silicona suave y extensible. Doble uso. También se puede utilizar como soporte de escritorio.

ITEM	REF.				
23000423002	playful	○	1		-



Soft pencil cases

Minimalist design with everyday functionality. High-quality soft silicone. Compact yet surprisingly spacious. Versatile, discreet and contemporary.

Estojo Silicone Soft

Design minimalista com funcionalidade diária. Silicone soft de alta qualidade. Compacto mas surpreendentemente espaçoso. Versátil, discreto e atual.

Trousse Soft

Design minimaliste et fonctionnalité au quotidien. Silicone souple de haute qualité. Compact mais étonnamment spacieux. Polyvalent, discret et moderne.

Estuches silicone Soft

Diseño minimalista con funcionalidad diaria. Silicona suave de alta calidad. Compacto pero sorprendentemente espacioso. Versátil, discreto y actual.

ITEM	REF.				
23000425533	25533	○	1		-



Animal key rings

Key rings with fun and expressive 3D designs feature animal characters in vibrant colours that add personality to backpacks, pencil cases, bags or keys. Made of soft and durable silicone, they are pleasant to the touch and ideal for everyday use by children, young people and adults alike. Lightweight and practical to carry.

Porta-chaves animais

Porta-chaves com design 3D divertido e expressivo, apresentam personagens de animais em cores vibrantes que acrescentam personalidade a mochilas, estojos, malas ou chaves. Em silicone macio e resistente, são agradáveis ao toque e ideais para uso diário, tanto por crianças como por jovens e adultos. Leves e práticos para transportar.



Porte-clés animaux

Porte-clés au design 3D amusant et expressif, représentant des animaux aux couleurs vives qui ajoutent de la personnalité aux sacs à dos, trousse, valises ou clés. En silicone souple et résistant, ils sont agréables au toucher et idéaux pour un usage quotidien, tant par les enfants que par les jeunes et les adultes. Légers et pratiques à transporter.

Llaveros animales

Llaveros con un divertido y expresivo diseño en 3D, con personajes de animales en colores vivos que añaden personalidad a mochilas, estuches, maletas o llaves. Fabricados en silicona suave y resistente, son agradables al tacto e ideales para el uso diario, tanto por niños como por jóvenes y adultos. Ligeros y prácticos de llevar.

ITEM	REF.				
11200420534	20534	6x4cm		12	



Horizontal leather pencil case

Leather cases conceived to transport and keep writing instruments. Machine stitched. With 1 or 2 zippers.

Estojo em pele horizontal

Bolsas em pele, com 1 ou 2 fechos, cosidas à máquina. Disponíveis a 1 ou várias tonalidades.

Trousse en cuir horizontal

Trousses en cuir pour transporter et placer instruments d'écriture. Avec 1 ou 2 fermetures à glissière et cousu à la machine.

Estuche de piel horizontal

Estuches en piel, con 1 o 2 zippers, cosidos a la máquina.

ITEM	REF.				
2300020001	001	○	1		12



Denim pencil cases

Jean cases conceived to transport and keep writing instruments. Machine stitched. With 1 or 2 zippers.

Estojo em ganga

Bolsas em ganga de várias tonalidades e formatos, com 1 ou 2 fechos, cosidas à máquina.

Trousse en jean

Trousses en jean pour transporter et placer les instruments d'écriture. Cousu à la machine. Avec 1 or 2 fermetures à glissière.

Estuches en ganga

Estuches en ganga, com 1 ou 2 zippers, cosidos a la máquina.

ITEM	REF.				
2300020007	007	○	1		12

ARCHIVE

ARQUIVO

ARCHIVES

ARCHIVO



re(mind) arch file

Cardboard folders lined with litho paper with a matt finish and localised uv varnish.

Pasta arquivo re(mind)

Pastas em cartão forrada a papel litografado com acabamento mate e verniz uv localizado.

Dossier re(mind)

Chemises en carton doublées de papier litho avec une finition mate et un vernis UV localisé.

Carpeta re(mente)

Carpetas de cartón forradas con papel litografiado con acabado mate y barniz uv localizado.

ITEM	REF.						
24700424302	re(mind)	2	320x260x45	L40mm		10	-
24700424303	re(mind)	2	320x260x75	L80mm		10	-





Neo:Style lever arch file

Lever arch file in cardboard covered with lithographic paper, rado plated and customized labels. Bright and pastel colors. For optimal organization of your office or home.

Classeur à levier neo:Style

Classeur à levier en carton avec revêtement au papier lithographié, rado chromé et porte-étiquettes personnalisable. Couleurs vifs et pastel. Pour une bonne organisation de votre bureau ou maison.

Pasta arquivo neo:Style

Pastas em cartão forradas a papel litografado, rado cromado e porta-etiquetas personalizável. Cores vibrantes e agora pastel. Para uma ótima organização do seu escritório ou casa.

Archivador de palanca neo:Style

Archivador de palanca en cartón revestido a papel litografado, rado cromado y etiquetero personalizable. Colores vibrantes y pastel. Para una óptima organización de su oficina o casa.

ITEM	REF.	Q	mm	L	mm	mm	mm
018004184402	aqua	2	320x290x45	L40	10	320	
018004184404	brick	2	320x290x45	L40	10	320	
018004184403	grey	2	320x290x45	L40	10	320	
018004184401	nautic	2	320x290x45	L40	10	320	
018004184802	aqua	2	320x290x75	L80	10	320	
018004184804	brick	2	320x290x75	L80	10	320	
018004184803	grey	2	320x290x75	L80	10	320	
018004184801	nautic	2	320x290x75	L80	10	320	



Classic lever arch file

Marble lever arch file in cardboard coated with varnish paper, metal protector edges and printed spine label.

Pasta arquivo nuvem clássica

Pastas em cartão forrada a papel litografado brilhante, calha metálica e rótulo impresso na lombada.

Classeur à levier classique

Classeur à levier en carton avec revêtement marbre plastifié, bord métallique, avec étiquette de dos imprimée.

Archivador de palanca clásica

Carpeta en carton forrada de papel plastificado sin brillo, cantoneras metálicas y etiqueta fija en el lomo.

ITEM	REF.	Q	mm	L	mm	mm	mm
01800444000	-	2	310x290x40	L40mm	30	480	
01800446000	-	2	310x290x60	L60mm	30	480	
01800448000	-	2	310x290x80	L80mm	25	400	



O ring binder

Cardboard ring binder coated with varnished colour paper.

Pasta arquivo L20

Pasta em cartão forrada a papel litografado com plasticização brilhante.

Classeur anneaux O

Classeur en carton avec revêtement papier lustré.

Carpeta de anillas redondas

Carpeta de anillas redondas en carton forrado de papel plastificado.

ITEM	REF.	Q	mm	L	mm	mm
0180042001	018L20	2	320x250x20	20mm	10	
0180042002	018L20	2	320x250x20	20mm	10	
0180042003	018L20	2	320x250x20	20mm	10	
0180042004	018L20	2	320x250x20	20mm	10	
0180042005	018L20	2	320x250x20	20mm	10	





Archival file

Marble file with plastic filing fastener, a printed spine label and a finger hole. Commercialised with a storage box.

Pasta arquivo definitivo

Arquivo definitivo com ferragem em plástico, óculo em aço cromado e rótulo impresso. Caixa rígida forrada a papel marmoreado.

Classeur d'archive AZ

Classeur d'archive final en carton marbré et boîte de classement rigide, avec une charnière, un attache en plastique A-Z, une étiquette d'identification au dos et un oeillet de préhension.

Archivo definitivo AZ

Archivo definitivo con mecanismo de plástico y rótulo impreso. Caja rígida forrada en papel jaspeado.

ITEM	REF.	Icon	Material	Color	Size	Weight	Quantity	OBS.	Assembly	Disassembly	Assembly	Disassembly	
0230010001	AZ-C	Commercial	Commercial	Commercial	Commercial	L80mm	310X240X75	assemb led	montada	monté	montada	5	200
0230040001	P-AZ-C	Commercial	Commercial	Commercial	Commercial	L80mm	310X240X75	disassembled	desmontada	démonté	desmontada	1	25
0230010003	AZ-A	foolscap	almoço	écolier	almacen	L80mm	350X240X75	assembled	montada	monté	montada	5	200



Archival box

Archival box in cardboard.

Caixa tipo francês

Caixa de arquivo tipo francês em cartão.

Boîte transfert

Boîte de classement en carton.

Caja de transferencia

Caja de archivo tipo francés en cartón.

ITEM	REF.	Icon	Material	Color	Size	Weight	Quantity
02411010000	CX0	foolscap	almoço	écolier	almacen	L10mm	365x275x100
02411010000	CX1				A4	L10mm	330x260x100



Archival box

Corrugated cardboard for archival storage, grid spaces for marking and labelling in 2 sides, finger holes. To be use as portrait or landscape format.

Caixa arquivo definitivo

Arquivo definitivo em cartão canelado, óculo e espaço para legendar informação.

Boîte d'archive final

Boîte d'archive final en carton ondulé pour utiliser comme portrait ou en paysage, avec lignes pour inscriptions dans 2 côtes et oeillet de préhension.

Archivo definitivo

Caja de archivo definitivo en cartón canelado, ollado y espacio para leyendas.

ITEM	REF.	Icon	Material	Color	Size	Weight	Quantity
0230042010	2010	Commercial	Commercial	Commercial	Commercial	L80mm	340X250X80
0230042500	2500	Commercial	Commercial	Commercial	Commercial	L160mm	340X250X160



Personalized binder

Polypropylene ring binder, 3 clear pockets to personalize (front, spine and back), one inner triangular pocket and plastic compressor.

Pasta catálogo personalizável

Pasta forrada em polipropileno branco, personalizável na capa, contra-capas e lombada, bolsa interior triangular e compressor em plástico.

Classeur de présentation personnalisable

Classeur blanc en polypropylène avec 3 faces personnalisables (couverture, dos et couverture arrière), mécanisme de 2 anneaux em D et pochette triangulaire dans l'intérieur.

Carpeta de anillas personalizable

Carpeta en polipropileno blanca, 2 anillas em D, bolsillo interior triangular, 3 bolsas transparentes personalizables (portada, lomo y dorso).

ITEM	REF.	Icon	Material	Color	Size	Weight	Quantity
07300473030	73030	2D	L16mm	A4	L30mm	12	48
07300473040	73040	2D	L25mm	A4	L40mm	12	36
07300473050	73050	2D	L35mm	A4	L50mm	12	36
07300473075	73075	2D	L55mm	A4	L75mm	6	24



PP ring binder

Rigid PP ring binder, opaque colors, personalizable spine and inner triangular pocket.

Capa catálogo PP

Capa em polipropileno rígido opaco, ferragem de anéis, lombada personalizável, bolsa interior triangular.

Dossier catalogue

Classeur de présentation opaque en polypropylène rigide, anneaux em D, dos personnalisable et pochette triangulaire dans l'intérieur.

Carpeta catalogo

Carpeta em polipropileno opaco, con anillas em D, lomo personalizable, fundas triangular en interior.

ITEM	REF.	Icon	Material	Color	Size	Weight	Quantity
24700424787	24787	2D	310x255x40	L40mm	A4	1	40

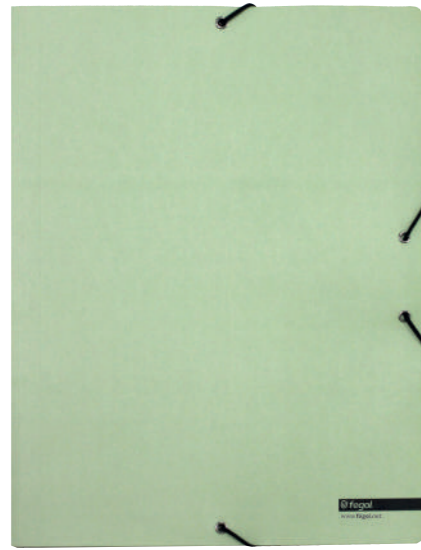

Cardboard flap elastic file

Cardboard flap elastic file with 3 flaps and elastic straps for safe closure.

Capa com elásticos em cartolina

Capa em cartolina de 350g/m2 com elásticos, 3 abas laterais e pequena lombada extensível.

Chemises en cartón

Chemise en cartón de 350g/m2 avec 3 rabats et élastiques.

Carpeta de gomas y solapas en cartulina

Carpeta en cartulina de 350g/m2 com gomas, 3 solapas y lomo extensible.

ITEM	REF.	Formato	g/m2	Elásticos	Flaps	Paquetes
248000335001	-	A3	440x320x15	350	5	80
248000335004	-	A3	440x320x15	350	5	80
248000335008	-	A3	440x320x15	350	5	80
248000335009	-	A3	440x320x15	350	5	80
248000335011	-	A3	440x320x15	350	5	80
248000435099	-	A4	310x230x15	350	5	100
24800035099	-	Foolscap Almaco Écolier Folio	350x235x15	350	1	25
248000535099	-	A5	-	350	1	10



Fibreboard flap elastic file

Fibreboard flap elastic file with 3 flaps and elastic straps for safe closure. Available in marble color.

Capa com elásticos fibra

Capa em cartão fibra marmoreado, com 3 abas e fecho com elástico.

Carpeta de gomas y solapas en fibra

Carpeta en cartón fibra jaspeado, con 3 solapas y gomas.

Chemises en carton fibré

Chemise en cartón fibré avec 3 rabats et élastiques.

ITEM	REF.	Formato	mm	Elásticos	Flaps	Paquetes
24800010093	1009/3	A3	430X310X35	1	10	
24800010083	1008/3	Foolscap Almaco Écolier Folio	350X235X35	1	10	
24800010073	1007/3	A4	310X230X35	1	10	



PP flap elastic file

PP elastic file with 3 flaps and elastic straps.

Capa com elásticos PP

Capa em polipropileno translúcido, com 3 abas e fecho com elásticos.

Carpeta de gomas y solapas en PP

Carpeta en polipropileno translúcido, con 3 solapas y gomas.

Chemises en PP

Chemise en PP translucide, avec 3 rabats et élastiques.

ITEM	REF.	Formato	mm	Elásticos	Flaps	Paquetes
2480022481399	2481399	A3	320X435X35	5	100	

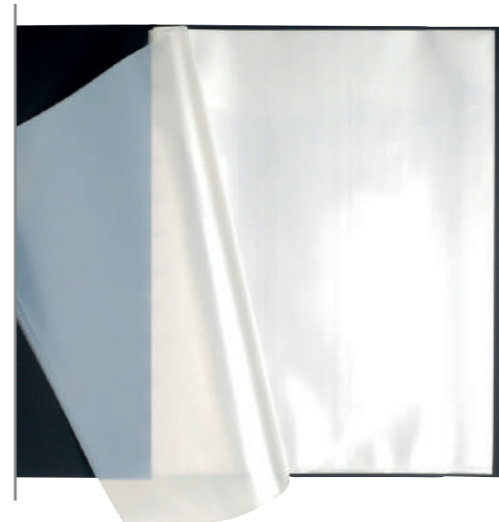

Display book

Display book with opaque cover and transparent polypropylene pockets. Cover and full length ticket hold on spine can be personalized. Pockets with top opening.



Pasta portfólio

Pasta em polipropileno semi-rígido com capa e lombada personalizáveis e bolsas transparentes com abertura superior.

Reliures souples

Reliures souples avec couverture opaque rigide et pochettes fixes en polypropylene. Couverture et dos personnalisables.

Carpeta de fundas personalizable

Carpeta en polipropileno semi-rígido en formato A4, con lomo y tapa personalizable, con fundas transparentes en su interior con apertura superior.

ITEM	REF.	Formato	Elásticos	Flaps	Paquetes
0730047310	7310	A4	10	20	72
0730047320	7320	A4	20	40	72
0730047330	7330	A4	30	60	36
0730047340	7340	A4	40	80	24
0730047360	7360	A4	60	120	24
0730047380	7380	A4	80	160	12
07300473100	73100	A4	100	200	12
07300473120	73120	A4	120	240	12



Colored display book

PP semi-rígido colored display book, translucide, A4, with top opening clear sleeves. Available in blue, red, green yellow, black, transparent and pastel colors.

Pasta portfólio colorido

Pasta em polipropileno semi-rígido colorido translúcido, no formato A4, e bolsas interiores transparentes com abertura superior. Disponível em azul, vermelho, verde, amarelo, preto, transparente e cores pastel.

Reliures souples

Protège-documents en polypropylène semi-rigide, translucide, A4 et vues transparents de ouverture supérieure. Disponible en bleu, rouge, vert, jaune, noir, transparent et pastel couleurs.

Carpeta de fundas

Carpeta de fundas en polipropileno, semi-rígido, translucido, tamaño A4 e fundas transparentes con abertura superior. Disponibles en azul, rojo, verde, amarillo, negro, transparente y colores pastel.

ITEM	REF.	Formato	Elásticos	Flaps	Paquetes
073004732001	7320-01	A4	20	40	72
073004732002	7320-02	A4	20	40	72
073004732003	7320-03	A4	20	40	72
073004732004	7320-04	A4	20	40	72
073004732005	7320-05	A4	20	40	72
073004732095	7320-95	A4	20	40	72
073004733001	7330-01	A4	30	60	36
073004733002	7330-02	A4	30	60	36
073004733003	7330-03	A4	30	60	36
073004733004	7330-04	A4	30	60	36
073004733005	7330-05	A4	30	60	36
073004733095	7330-95	A4	30	60	36

ITEM	REF.	Formato	Elásticos	Flaps	Paquetes
073004734001	7340-01	A4	40	80	24
073004734002	7340-02	A4	40	80	24
073004734003	7340-03	A4	40	80	24
073004734004	7340-04	A4	40	80	24
073004734005	7340-05	A4	40	80	24
073004734095	7340-95	A4	40	80	24



Presentation flat folder PP 257

PP presentation folder with flat bar mechanism, clear front cover and personalizable full length label hold on spine.

Classificador com ferragem PP 257

Classificador em polipropileno, capa transparente, contra-capa opaca, ferragem de latão e porta etiquetas longitudinal.

Chemise de présentation PP 257

Chemise de présentation en PP, couverture transparente et opaque, avec un mécanisme à lamelle en laiton et porte-étiquettes verticale.

Carpeta dossier fastener PP 257

Carpeta de polipropileno con tapa transparente y contra tapa opaca, fastener de metal y porta etiquetas longitudinal.

ITEM	REF.	Formato	Altura	Cor	Ferragem	Quantidade
07500425701	257	A4	60	Preto	25	500
07500425702	257	A4	60	Branco	25	500
07500425703	257	A4	60	Vermelho	25	500
07500425704	257	A4	60	Verde	25	500
07500425705	257	A4	60	Azul	25	500
07500425706	257	A4	60	Amarelo	25	500
07500425707	257	A4	60	Roxo	25	500
07500425708	257	A4	60	Laranja	25	500
07500425711	257	A4	60	Pink	25	500
07500425712	257	A4	60	Ciano	25	500
07500425713	257	A4	60	Purpura	25	500



Presentation flat folder PVC 263

PVC presentation folder with opaque colored cover, flat bar mechanism and a vertical inside pocket on the back cover.

Classificador com ferragem PVC 263

Classificador em PVC, capa opaca, ferragem de plástico, bolsa interior vertical, rectangular, na contra capa.

Chemise de présentation PVC 263

Chemise de présentation en pvc opaque avec mécanisme à lamelle en plastique et une pochette intérieure transparent.

Carpeta dossier fastener PVC 263

Carpeta de plástico, tapa opaca, fastener de plástico, funda interior vertical, rectangular, en contra tapa.

ITEM	REF.	Formato	Altura	Cor	Ferragem	Quantidade
07507826301	263	A4	60	Preto	1	100
07507826302	263	A4	60	Branco	1	100
07507826303	263	A4	60	Vermelho	1	100
07507826304	263	A4	60	Verde	1	100
07507826305	263	A4	60	Azul	1	100
07507826306	263	A4	60	Amarelo	1	100
07507826307	263	A4	60	Roxo	1	100



Presentation flat folder PVC 419

PVC presentation folder with flat bar, clear front cover with colored back. Personalizable full length label holder.

Classificador com ferragem PVC 419

Classificador em plástico de acabamento liso, capa transparente, contra-capa opaca, ferragem plástica e porta etiquetas longitudinal.

Chemise de présentation PVC 419

Chemise de présentation en PVC, couverture transparente et opaque, avec un mécanisme à lamelle en plastique et porte-étiquettes verticale.

Carpeta dossier fastener PVC 419

Carpeta de plástico acabado liso, tapa transparente y contra tapa opaca, fastener de plástico y porta etiquetas longitudinal.

ITEM	REF.	Formato	Altura	Cor	Ferragem	Quantidade
07500441901	419	A4	80	Preto	25	250
07500441902	419	A4	80	Branco	25	250
07500441903	419	A4	80	Vermelho	25	250
07500441904	419	A4	80	Verde	25	250
07500441905	419	A4	80	Azul	25	250
07500441906	419	A4	80	Amarelo	25	250
07500441907	419	A4	80	Roxo	25	250

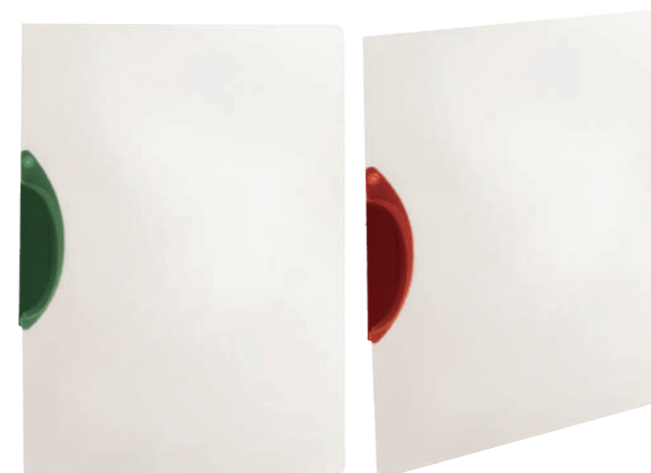

Presentation swing clip folder

Transparent PP presentation folder with a strong retention colored clip. The cover can open entirely at 180°.

Classificador swing clip 226

Classificador em polipropileno rígido com capa e contra-capa transparente, mola de clip em meia lua, amovível.

Chemise à clip swing 226

Chemise avec une couverture et dos rigides en polypropylène translucide, mécanisme à clip pivotant, amovible.

Carpeta swing clip 226

Carpeta en polipropileno rígido con tapa y trasera transparentes, clip de media luna, amovible.

ITEM	REF.	Formato	Altura	Cor	Ferragem	Quantidade
075055226622	226	A4	30	Preto	20	80
075055226632	226	A4	30	Vermelho	20	80
075055226684	226	A4	30	Azul	20	80



Presentation clip folder 220

PP presentation folder with a strong steel clip, clear front cover and semi-rigid colored back. A4 documents. Capacity: 30 sheets.

Classificador com clip 220

Classificador PVC com clip especial arqueado, capa transparente na frente e colorida na parte lateral (banda) e capacidade para arquivar até 30 folhas.

Chémise à clip 220

Chemise avec mécanisme à clip, couverture transparente et dos de couleur opaque en PVC rigide.

Carpeta dossier clip 220

Carpeta pvc con clip especial arqueado, tapa transparente y trasera opaca en diferentes colores.

ITEM	REF.	Formato	Altura	Cor	Ferragem	Quantidade
075055220002	220	A4	30	Preto	25	100
075055220003	220	A4	30	Branco	25	100
075055220005	220	A4	30	Vermelho	25	100
075055220006	220	A4	30	Verde	25	100
075055220007	220	A4	30	Azul	25	100
075055220021	220	A4	30	Amarelo	25	100
075055220031	220	A4	30	Roxo	25	100



Presentation kraft folder 145C

Kraft presentation folder with 240g/m2, flat bar mechanism and a lateral flap. Ideal to present projects.

Dossier kraft 145C

Dossier em kraft com 240g/m2, ferragem de plástico e uma aba lateral.

Chemise en kraft 145C

Chemise en kraft 240g/m2 avec lamelle en plastique et une rabat latéral.

Carpeta dossier kraft 145C

Carpeta dossier en kraft 240g/m2, fastener de plástico y una solapa lateral.

ITEM	REF.	320x235mm	40	240	25	100
0760040145	145C					



Envelope folder with spring closure

Plastic transparent envelope folder with spring closure.

Bolsa tipo envelope com mola

Bolsa em plástico transparente mate, tipo envelope com abertura no topo e fecho em mola.

Dossier pochette à bouton de pression

Dossier pochette en plastique transparent avec ouverture haute et fermeture par bouton de pression.

Sobres portadocumentos de mola

Funda de plástico transparente mate tipo sobre con apertura superior y cierre de mola redonda de plástico.

ITEM	REF.	310x230mm	12	180
074000510231	E105	310x230mm	12	180
074000510232	E105	310x230mm	12	180
074000510233	E105	310x230mm	12	180
074000510234	E105	310x230mm	12	180
074000510237	E105	310x230mm	12	180
074000510235	E105	310x230mm	12	180
074000510236	E105	310x230mm	12	180
074000510237	E105	310x230mm	12	180



Cardboard window folder 76395

Cardboard folder, L shape, pre-printed cover for notes and a transparent window.

Dossier protocolo 76395

Dossier fabricado em cartolina, abertura em L, capa impressa para personalização e janela translúcida.

Chemise à fenêtre 76395

Dossier en carton, ouverture L, la couverture pré-imprimée pour des annotations et une fenêtre transparente.

Subcarpeta en cartulina 76395

Subcarpeta en cartulina con abertura en L, tapa impressa para identificación del contenido y una ventana transparente.

ITEM	REF.	310x220mm	30 - 50	140	25	500
076004763951	76395	310x220mm	30 - 50	140	25	500
076004763952	76395	310x220mm	30 - 50	140	25	500
076004763953	76395	310x220mm	30 - 50	140	25	500
076004763954	76395	310x220mm	30 - 50	140	25	500
076004763955	76395	310x220mm	30 - 50	140	25	500



Envelope folder velcrom

Envelope file folder in translucent propylene, ideal for A4 and A5 documents and everyday used cards. With hook-and-loop closure to keep contents secure. Assorted colors available.

Bolsa tipo envelope com velcro

Bolsa tipo envelope em polipropileno translúcido de cores sortidas, ideal para arquivar documentos nos formatos A4, A5 e dos cartões de utilidade diária, tais como cartões de estudante, visita, cidadão, multibanco entre outros. Abertura no topo e fecho em velcro.

Dossier pochette à velcro

Dossier pochette à propylène transparent, idéal pour documents A4 et A5 et cartes d'utilisation quotidienne. Avec fermeture en velcro pour garder le contenu. Couleurs assorties disponibles.

Sobres portadocumentos con velcro

Carpeta archivadora en propileno transparente, ideal para documentos A4 y A5 y tarjetas de uso diario. Con cierre de velcro para mantener el contenido seguro. Colores variadas disponibles.

ITEM	REF.	A4	12	180
07400410601	E106-01	A4	12	180
07400410603	E106-03	A4	12	180
07400410604	E106-04	A4	12	180
07400410605	E106-05	A4	12	180
07400410695	E106-95	A4	12	180
07400410701	E107-01	A5	12	360
07400410703	E107-03	A5	12	360
07400410704	E107-04	A5	12	360
07400410705	E107-05	A5	12	360
07400410803	E107-95	A5	12	360
07400410706	E107-06	A5	12	360
07400410707	E107-07	A5	12	360
07400410708	E107-08	A5	12	360

ITEM	REF.	105x65mm	10	480
07400410801	E108-01	105x65mm	10	480
07400410803	E108-03	105x65mm	10	480
07400410804	E108-04	105x65mm	10	480
07400410805	E108-05	105x65mm	10	480
07400410895	E108-95	105x65mm	10	480



Plastic folder with label holder 21-A

Plastic folder open up to 180°, label holder and a transparent pocket inside to fasten documents.

Bolsa arquivo 21-A

Bolsa em plástico com abertura a 180°, porta etiquetas personalizável e resguardo diagonal no interior.

Chemise de presentation 21-A

Chemise de presentation en plastique, format commercial, ouverture a 180°, porte-étiquettes personnalisable et une pochette diagonale dans l'intérieur.

Dossier de presentación 21-A

Funda de plástico resistente con abertura a 180°, porta etiquetas personalizable y bolsa diagonal interior para portar documentos.

ITEM	REF.					
0740042195	21A		310x230mm		10	500
0740782101	21A		310x230mm		10	500
0740782103	21A	commercial	310x230mm		10	500
0740782104	21A	commercial	310x230mm		10	500
0740782105	21A	commercial	310x230mm		10	500
0740782107	21A	commercial	310x230mm		10	500
0740782106	21A		310x230mm		10	500
0740782107	21A		310x230mm		10	500
0740782108	21A		310x230mm		10	500



Clear folder L shape

L shape plastic folder with side and top opening. Thumb hole for easy access.

Bolsas arquivo em L

Bolsa em plástico transparente mate, abertura em L (topo e lateral) e meia lua para facilitar a consulta.

Chemise coin ouverture en L

Chemise coin en plastic transparent, format commercial, ouverture en L (haut et lateral) et demi lune pour faciliter la consultation.

Dossier de presentación en L

Funda de plástico transparente mate tipo comercial, abertura en L (cima e lateral) y media luna para facilitar la consulta.

ITEM	REF.					
07400640095	6400		310x230mm		100	1000
07400640001	6400	commercial	310x230mm		100	500
07400640003	6400	commercial	310x230mm		100	500
07400640004	6400	commercial	310x230mm		100	500
07400640005	6400	commercial	310x230mm		100	500

Punched pockets

Pockets with anti-glare finish, top opening, reinforced multi-punched spine for any kind of binder.

Bolsas catálogo / micas

Bolsas catálogo em polipropileno transparente, reforçado para proteção de documentos, abertura no topo, furação universal, banda de reforço.

Pochettes perforées

Pochettes en polypropylene transparent anti-statique pour protéger les documents, avec bande et perforation renforcées.

Fundas multitaladros

Fundas cristal en polipropileno transparente antirreflejo, con abertura superior, perforación universal y lomo reforzado.

ITEM	REF.				
0720040010	W10	25 microns	A4	100	3000
0720000015	W15	40 microns	A4	100	2000
0720042510	W25	60 microns	A4	100	2000
0720040045	W45	80 microns	A4	100	1000
0720040050	W50	100 microns	A4	100	1000
0720040060	W60	120 microns	A4	100	1000
0720045100	Y50	100 microns	A5	100	2000
07200499901	W15-10	40 microns	A4	10	-
0720044510	W45-10	80 microns	A4	10	100
07200499902	W50-10	100 microns	A4	10	100
07200400601	W60-10	120 microns	A4	10	100
07200499903	Y50-10	100 microns	A5	10	-

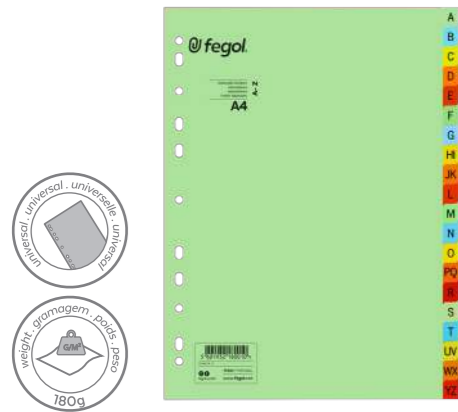

Cardboard insertable dividers

180g/m² cardboard insertable dividers set available in smooth or intense assorted colors. Tabs for easy writing or identification with numerical decreasing order, A-Z and month, index sheet printed, universal punch (11 holes).

Índices separadores cartolina

Coleção de separadores fabricados em cartolina de 180g/m², cores suaves ou intensas, com impressão na primeira página ou nas pestanas escalonadas e furação universal.



Intercalaires en cartón

Jeu d'intercalaires en cartón de 180g/m², couleurs assorties pour une usage intensif. Les onglets permettent d'écrire et de défaire de nombreux fois. Lisses et imprimé avec numéraux, A-Z et mois. Perforation universelle (11 trous).

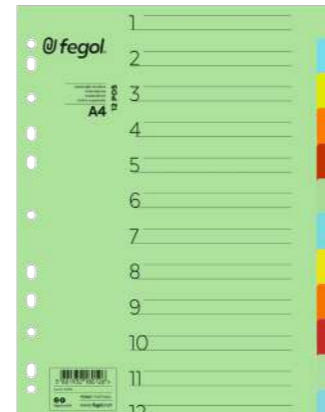

Separadores de cartulina

Colección de separadores fabricados en cartulina de 180g/m², colores suaves o intensas, impresión en la primera página o en las pestañas, perforación universal.

ITEM	REF.	OBS.	g/m ²	Color	11 holes	150 holes
013002400199	-	A4 A-Z	180	Green	50	-
0130024699	-	A4 6	180	Green	250	-
0130024899	-	A4 8	180	Green	100	-
013002410990	-	A4 10	180	Green	100	-
01300241299	-	A4 12	180	Green	100	-
01300241899	-	A4 18	180	Green	50	150
01300242499	-	A4 24	180	Green	50	-
0130024310	-	A4 31	180	Green	50	-

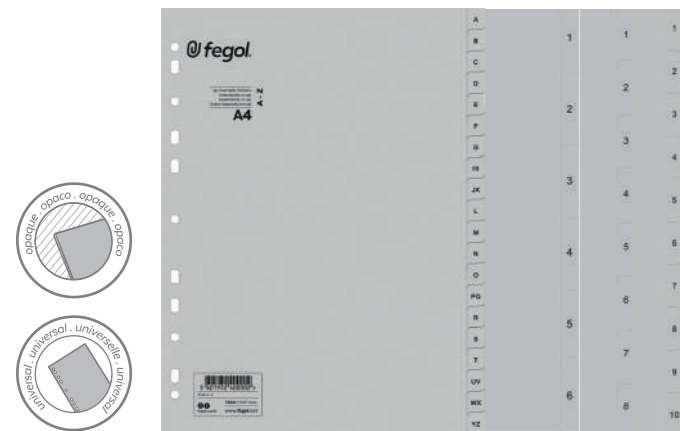

PP insertable dividers

Polypropylene dividers set with printed numerical/alphabetical tabs. Universal punch (11 holes).

Índices separadores PP

Coleção de separadores fabricados em polipropileno com impressão nas pestanas escalonadas e furação universal.

Intercalaires en PP

Jeu d'intercalaires en polypropylène avec onglets imprimés numériques/alphabétiques. Perforation universelle (11 trous).

Separadores en PP

Colección de separadores fabricados em polipropileno con las pestañas escalonadas y perforación universal.

ITEM	REF.	OBS.	g/m ²	Color	11 holes	150 holes
01300240011	-	A4 A-Z	60	Grey	60	-
0130024600	-	A4 6	200	Grey	200	-
0130024800	-	A4 8	150	Grey	150	-
0130024100	-	A4 10	120	Grey	120	-
01300241200	-	A4 12	100	Grey	100	-



School insertable dividers

PP dividers with grain embossing, personalizable tabs with pre-cut printed labels. Universal punch (11 holes) to fit most filing system.

Índices separadores escolares

Coleção de separadores em PP estriado, pestanas coloridas personalizáveis e furação universal. Inclui etiquetas com nome das disciplinas escolares.

Intercalaires scolaire

Jeu d'intercalaires en PP de couleurs assorties. Onglets personnalisables et perforation universelle (11 trous). Etiquettes imprimées avec les noms des cours.

Separadores escolares

Colección de separadores fabricados em polipropileno estriado, pestañas coloridas personalizables y perforación universal.

ITEM	REF.	OBS.	g/m ²	Color	11 holes	150 holes
0130024146	14-PL	A4 6	10	Green	10	150

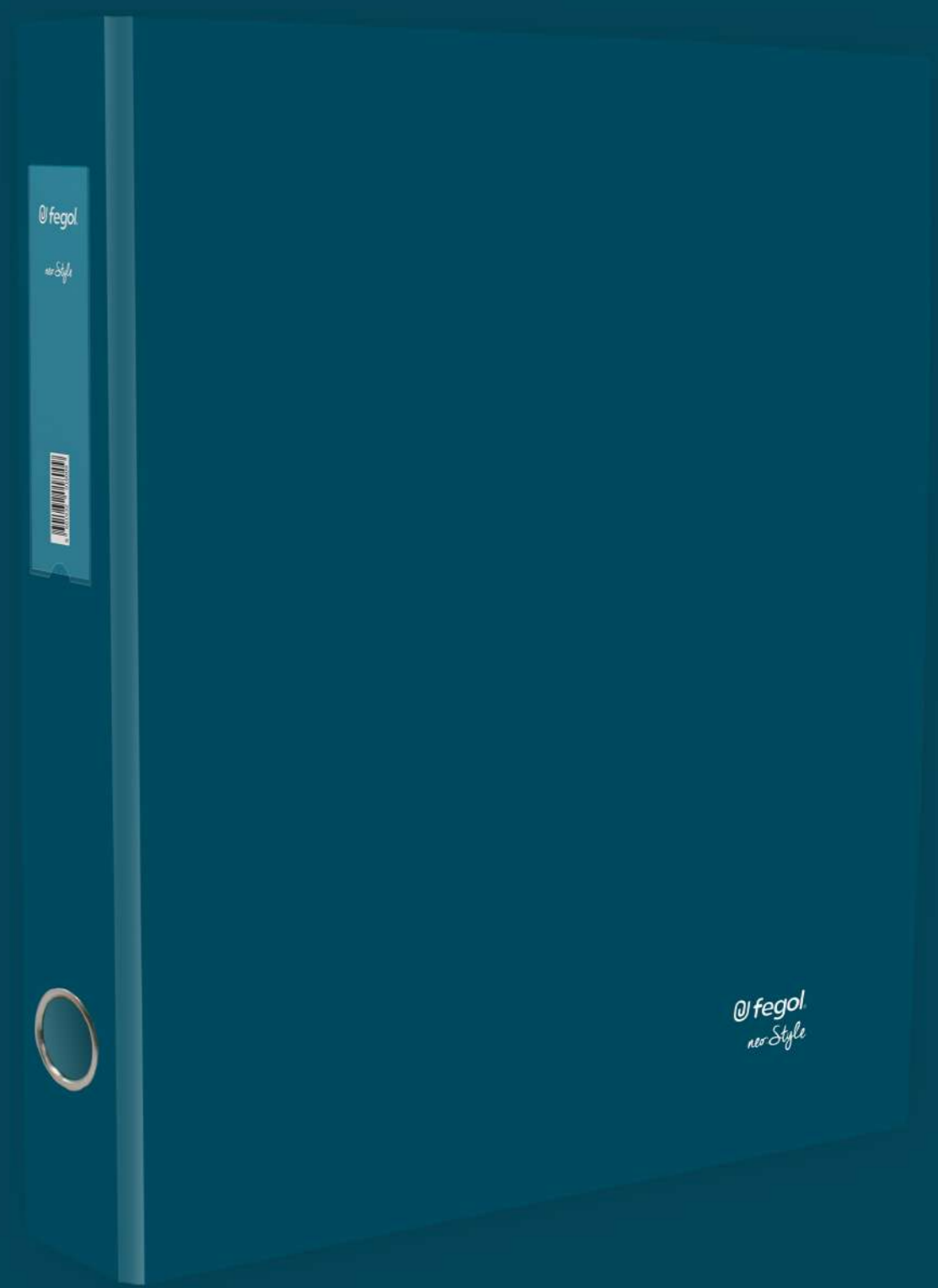

ORGANIZATION

ORGANIZAÇÃO

ORGANIZACIÓN

ORGANISATION



Staplers

Metal frame stapler, heavy-duty plastic cover, with top loading, automatic backfeed and non-slip rubber base. References 511 and 513 incorporate a staple remover.

Agrafadores

Agrafadores de estrutura metálica, cobertura em plástico resistente, carregadores superiores, alimentador de retrocesso automático e base em borracha anti-derrapante. As referências 511 e 513 incorporam um extractor de agrafos.

Agrafeuses

Agrafeuse en métal avec embout en plastique et base acouchoutée. Agrafe et épingle. Mécanisme de rechargement par le haut. Les références 511 et 513 ont un dégrafeur.

Grapadoras

Grapadoras de estructura metálica, revestimiento en plástico, con cargadores superiores, alimentador de retroceso automático y base en goma antideslizante.

ITEM	REF.											
0700040511	511	Nº 10	10		✓	✓	✓	✓	✓	✓	✓	144
0700040513	513	Nº 10	10		✓	✓	✓	✓	✓	✓	✓	144
0700040517	517	Nº25-21/4	10		✓	✓	✓	✓	✓	✓	✓	240
0700040578	578	Nº24/6	20		✓	✓	✓	✓	✓	✓	✓	72
0700040597	597	Nº24/6	20		✓	✓	✓	✓	✓	✓	✓	96
0700040599	599	Nº24/8-26/8	50		✓	✓	✓	✓	✓	✓	✓	72
07000499905	513-BLT	Nº 10	10		✓	✓	✓	✓	✓	✓	✓	10
07000405171	517-BLT	Nº25-21/4	10		✓	✓	✓	✓	✓	✓	✓	24
07000499906	597-BLT	Nº24/6	20		✓	✓	✓	✓	✓	✓	✓	9



Plier staplers

Metal full-strip plier with a fastener device anti-shot. Backloading.

Agrafadores alicate

Agrafador tipo alicate em metal cromado com abertura posterior para recarregamento e dispositivo de fecho anti-disparo.

Pincès à agraffer

Pincès à agraffer en acier chromé, poignée ergonomique, alimentation arrière, dispositif antiblocage breveté.

Grapadora tenaza

Grapadora tipo tenaza en metal cromado, abertura posterior para recargar las grapas, dispositivo de cierre anti-disparo.

ITEM	REF.	Icon 1	Icon 2	Icon 3	Icon 4	Icon 5	Icon 6	Icon 7	Icon 8
0700040542	542	Nº25-21/4	8	X	X	✓	✓	12	60
0700040522	522	Nº10	15	X	X	✓	✓	12	72
0700040562	562	Nº24/6	25	X	X	✓	✓	12	60
0700040572	572	Nº24/6-24/8+	40	X	X	✓	✓	12	60
07000499907	522-BLT	Nº10	15	✓	✓	✓	✓	1	14



Staples

Galvanized staples in wire of high quality.

Agrafos

Agrafos galvanizados fabricados em arame de elevada qualidade.

Agrafes

Agrafes galvanisés fabriqués en fil de fer de haute qualité.

Grapas

Grapas galvanizadas fabricadas con alambre de elevada calidad.

ITEM	REF.	Icon 1	Icon 2	Icon 3	Icon 4	Icon 5	Icon 6	Icon 7	Icon 8
0710047110	7110	Nº10	10	1000	-	10	1000		
0710047125	7125	Nº25-21/4	12	1000	-	10	1000		
07100471255	71255	Nº25-21/4	12	5000	-	5	250		
07100471246	71246	Nº24/6	20	1000	-	10	500		
07100471248	71248	Nº24/8	60	5000	-	5	100		
071004712310	712310	Nº23/10-9/10	70	5000	-	1	40		
07100471102	7110-BLT	Nº10	10	-	2	-	20		
071004712462	71246-BLT	Nº24/6	20	-	2	-	20		



Heavyduty stapler

Heavy duty stapler, tough steel mechanism, easy push-button for front staples loading, rubber feet, adjustable paper.

Agrafador grande capacidade

Agrafador de grande capacidade, alavanca ergonómica, base anti-deslizante, mecanismo em aço, carregamento frontal.



Agrafeuse lourde haute capacité

Agrafeuse lourde haute capacité, poignée ergonomique, changement simple avec bouton poussoir, guide papier réglable.

Grapadora de gran capacidad

Grapadora de gran capacidad, en acero resistente, palanca ergonómica, sistema de grapado con guía, carga frontal automática.

ITEM	REF.	Icon 1	Icon 2	Icon 3	Icon 4	Icon 5	Icon 6	Icon 7	Icon 8
0700040989	989	Nº9/6, 9/8, 9/10, 9/13	100	✓	✓	✓	✓	1	12



Staple remover

Staple remover in metal structure with stainless steel spring, finger grips.



Desagrafador

Desagrafadores tipo alicate, base metálica, mola de aço, punho de estrias antideslizantes.



Pincès à dégraffer

Dégrafeur type pincès en structure métallique avec un ressort en acier.

Extraeagrapas

Extraeagrapas tipo tenaza totalmente metálica o tipo pinza de plástico y metal.

ITEM	REF.	Icon 1	Icon 2	Icon 3	Icon 4	Icon 5	Icon 6	Icon 7	Icon 8
06800400509	509		✓	✓	✓	12	240		
06800400508	508		✓	✓	✓	24	432		
06800499909	508-BLT		✓	✓	✓	1	20		



908



918



968



988



Paper punches

Metal paper punches with plastic cover, non-slip plastic base, waste removable tray and handle lockdown.

Furadores

Perfuradores de estrutura metálica com tampa plástica, marcador central, base anti-deslizante e reservatório.

Perforateurs 2 trous

Perforateurs en métal et couverture en plastique, un réceptacle à confetis amovible en plastique, base antidérapante.

Taladros

Taladros de metal con tapa superior de plástico, marcador centrado y base antideslizante con base extraíble.

ITEM	REF.	10	20	30	40	12	72
0690040908	908	10	2	X		12	72
0690040918	918	20	2	X		12	72
0690040968	968	30	2	✓		12	36
0690040988	988	40	2	✓		6	24



Heavy duty paper punch

Metal paper punch of high capacity with ABS plastic lever, non-slip plastic base, handle lockdown for compact storage and removable tray.

Furador grande capacidade

Perfurador de grande capacidade em metal com alavanca de plástico ABS, reservatório, travão de segurança e base anti-deslizante.

Perforateur grand capacité

Perforateur grand capacité en métal avec poignée ergonomique, système de blocage du levier, réceptacle à confetis amovible en plastique et base antidérapante.

Taladro gran capacidad

Taladro de gran capacidad en metal con palanca de plástico ABS, base extraíble, freno de seguridad, base antideslizante.

ITEM	REF.	70	2	1	6
0690040937	937	70	2	1	6



Extra heavy duty paper punch

Extra heavy duty punch with ergonomic handle, metal ruler, solid metal punching mechanism, rigid plastic base.

Furador grande capacidade extra

Perfurador de capacidade extra com alavanca ergonómica, régua marginadora metálica, mecanismo de perfuração metálico sólido, base plástica.

Perforateur capacité extra

Perforateur de capacité extra avec poignée ergonomique, reglette métallique, mécanisme de perforation en métal solide, réservoir en plastique.

Taladro de capacidad extra

Taladro de capacidad extra, palanca ergonómica, regleta metálica, mecanismo de punziones metálico sólido, cubeta recogepapel en plástico.

ITEM	REF.	150	2	1	6
0690040999	999	150	2	1	6



Key-holder

Plastic key holder with a simple ring and a personalized white label.



Porta-chaves

Porta-chaves de plástico reforçado para identificação com uma etiqueta branca e com argola metálica.

Porte-clés

Porte-clés en plastique avec un porte-clés et une étiquette interchangeable personnalisable.

Llavero

Llavero de plástico reforzado para la identificación con una etiqueta blanca y anillo de metal.

ITEM	REF.	10	12	144
11200411299	112-99	10	12	144
112275300010	300/010/3200	50	1	4000



Fingerstalls

Rubber fingerstall with a wrinkled surface to help documents consultation.



Dedeiras

Dedeiras em borracha com superfície rugosa para auxiliar a consulta de documentos.

Doigtiers

Doigtier en caoutchouc avec une surface rugueuse pour auxilier la consultation de documents.

Dediles

Dediles fabricados en goma con superficie rugosa para auxiliar la consulta de documentos.

ITEM	REF.	Nº	15mm	17mm	18mm	20mm
10200410200	10200	00	10	300		
1020041020	1020	0	10	300		
10200410201	10201	1	10	300		
10200410202	10202	2	10	300		



Paper clips

Paper clips made from high quality zinc plated.

ITEM	REF.	mm				
0100040001	010-CX1	6,2x22,5mm	○	△	■	▭
0100040002	010-CX2	8,5x30mm	○	△	■	▭
0100040003	010-CX3	11x20,5mm	○	△	■	▭
0100040004	010-CX4	10x33mm	○	△	■	▭
0100040010	010-CX10	15x50mm	○	△	■	▭

Clips

Clips de arame zincado dobrados de forma redonda ou triangular.

Trombones

Trombone en acier zingué

Sujetapapeles

Sujetapapeles en alambre cincado doblados de forma redonda o triangular.



Colored paper clips

Colored paper clips made from nickel steel with a smooth vinyl coating.

ITEM	REF.	mm				
0100040102	Nº2	8,5x30mm	○	■	▭	▭
0100040104	Nº4	10x33mm	○	■	▭	▭
01000401010	Nº10	15x50mm	○	■	▭	▭

Clips revestidos

Clips de arame revestidos a vinil de várias cores.

Trombones colorés

Trombone en acier double avec vinyle de couleurs sorties.

Clips plastificados

Clips en alambre revestidos en plástico de vários colores.



Binder clips

Stainless steel binder clips with flexible chromium plated clips.

Molas para papéis

Molas em aço inoxidável e clips cromados flexíveis.

ITEM	REF.	Nº							
0500001019	109	1	19mm	60	12			144	3600
05000405019	050-19	1	19mm	60	12	✓		12	144
0500002025	209	2	25mm	80	12			144	2880
05000405025	050-25	2	25mm	80	6	✓	✓	12	144
0500003032	309	3	32mm	110	12			144	1440
05000405032	050-32	3	32mm	110	4	✓		12	288
0500004041	409	4	41mm	170	12			12	1296
05000405041	050-41	4	41mm	170	4	✓		12	144
0500005051	509	5	51mm	200	12			12	720
05000405053	050-51	5	51mm	200	4	✓	✓	12	288



Binder clips

Painted metal binder clips with flexible chromium plated clips.

Molas para papéis

Molas em metal pintado com pega para dobrar.

ITEM	REF.	Nº					
0500040501	050-1	1	19mm	60	12	12	144
0500040502	050-2	2	25mm	80	12	12	144
0500040503	050-3	3	32mm	110	12	12	144

Pinces double clip

Pinces double en acier inoxydable et clips chromé flexible.

Pinzas de pala abatible

Pinzas en acero inoxidable y clips cromados flexibles.





Badge holder with combi clip

Plastic badge holder with a combination alligator clip and safety pin. Insertion opening on the back to introduce or remove cards easily. Card included.

Porte-badge avec pince combi

Porte-badge en plastique transparent avec un double système d'attache: épingle et pince crocodile. Ouverture d'insertion arrière. Contient carte.

ITEM	REF.			
1640041641	164-1	57x90mm	10	100



Porta-nomes com mola

Porta nomes em plástico transparente rígido com mola metálica, alfinete e abertura de encaixe no verso. Inclui cartão.

Identificador con pinza combi

Porta nombres en plástico transparente rígido con pinza metálica. Inserción de apertura en la parte posterior. Tarjeta incluida.



Rubber bands

Rubber bands produced from natural rubber of high quality with several applications and good resistance.

Bracelets élastiques

Bracelet fabriqué de gomme naturelle de haute qualité avec beaucoup d'utilisations et très résistant.

Elásticos

Borracha natural com múltiplas aplicações e bastante resistência.

Gomas elásticas

Goma natural con múltiples aplicaciones y bastante resistencia.

ITEM	REF.			
1190040010	Nº10	35x11mm	1 kg	20
1190040012	Nº12	45x11mm	1 kg	20
1190040014	Nº14	50x11mm	1 kg	20
1190040016	Nº16	60x11mm	1 kg	20
1190040018	Nº18	80x11mm	1 kg	20
1190040020	Nº20	100x11mm	1 kg	20
1190040032	Nº32	80x3x12mm	1 kg	20
1190040033	Nº33	90x3x11mm	1 kg	20
1190040034	Nº34	100x3x11mm	1 kg	20
1190040038	Nº38	160x3x11mm	1 kg	20
1190040089	Nº89	160x12x11mm	1 kg	20
1190040091	Nº91	200x12x11mm	1 kg	20
1190041025	Nº10	35x11mm	25 gr	40
1190041425	Nº14	50x11mm	25 gr	40
1190041625	Nº16	60x11mm	25 gr	40
1190041825	Nº18	80x11mm	25 gr	40
1190043325	Nº33	90x3x11mm	25 gr	40
1190043825	Nº38	160x3x11mm	25 gr	40
1190048925	Nº89	160x12x11mm	25 gr	40
11900491100	Nº91	200x12x11mm	100 gr	40



Badge holder with necklace

Plastic badge holder with textile necklace with safety closure and a plastic spring hook. Opening at the top to remove or introduce cards.

Porte-badge avec lacet

Porte-badge en plastique transparent avec lacet textile coloré et épingle de plastic. Ouverture par le haut.

Porta-nomes com cordão

Porta nomes em plástico transparente com cordão em tecido, desbloqueador de segurança e mola tipo gancho. Abertura na parte superior para remover o cartão.

Identificador con cinta

Porta nombres en plástico transparente con cordón en tejido que incluye un desbloqueador de seguridad y una pinza tipo gancho. Apertura en la parte superior para introducir o quitar tarjetas.

ITEM	REF.			
1640041642	164-2	105x75mm	10	840
1640041644	164-4	95x68mm	10	50



Card holder with necklace

Rigid card holder + necklace for business cards/documents.

Porta-cartões com cordão

Porta-cartões rígidos + cordões para cartões de visita/documentos.

Porte-cartes avec lacet

Porte-cartes rigide + lacets pour cartes de visite/documents.

Tarjetero con cinta

Tarjetero rígido + cordones para tarjetas de visita/documentos.

ITEM	REF.			
1670041673	167-3	95x68mm	3	8



Adhesive putty

Removable adhesive putty ideal to fix light weight objects on all surfaces. Non-toxic. Reusable.

Goma adesiva

Massa adesiva removível para fixar objetos em todas as superfícies. Não deixa marcas quando se retira. É reutilizável.

Pâte adhesive tac

Pâte adhésive, repositionnable, attache objets légers sur toutes les surfaces. Ne laisse aucune marque une fois enlevé. Réutilisable. Non toxique.

Goma adhesiva

80 puntos de masilla adhesiva removible, utilizable en superficies no porosas. No deja marcas.

ITEM	REF.					
3220040001	-	80	60	12	144	



Stamp pad

Metallic box with a pad to rubber stamps.

Almofada para carimbo

Almofada para carimbos de borracha reutilizável. Caixa metálica.

Tampon encreur

Boîte métallique avec un tampon encreur.

Almofadilla para tampones

Almofadilla para tampones de goma. Caja metálica.

ITEM	REF.	mm	Color	12	144
0590040201	N°2	120x80mm	Blue	12	144
0590040202	N°2	120x80mm	Black	12	144
0590040203	N°2	120x80mm	Red	12	144
0590040204	N°2	120x80mm	Green	12	144



Desk organizer kit

Metal mesh organizer kit with 6 pieces: pencil holder, business cards holder, memo holder, letters shelf, clip holder and waste bin.

Conjunto de escritório

Conjunto de escritório com 6 peças metálicas de rede para escritório. Inclui: porta lápis, porta-cartões, porta papel, porta envelopes, porta clips e balde do lixo.

Kit organiser de bureau

Kit organiser avec 6 pièces: pot à crayons, porte cartes, porte notes, porte lettres, porte clips et poubelle.

Kit organizador de escritorio

Kit organizador en metal con 6 piezas: taza de lápices, porta tarjetas, porta notas, porta cartas, porta clips y papelera.

ITEM	REF.	mm	1	4
23000402306	230-6		1	4



Stamp ink

Ink without oil for rubber stamp pads.

Tinta para carimbo

Tinta para almofadas de carimbo de borracha sem óleo.

Encre pour tampon

Encre sans huile pour tampon caoutchouc. Flacon plastique auto-encreur de 30ml.

Tinta de sellar

Tinta para reentintar los tampones de goma sin óleo.

ITEM	REF.	mm	Color	12	360
0420040001	-	30ml	Blue	12	360
0420040002	-	30ml	Black	12	360
0420040003	-	30ml	Red	12	360
0420040004	-	30ml	Green	12	360

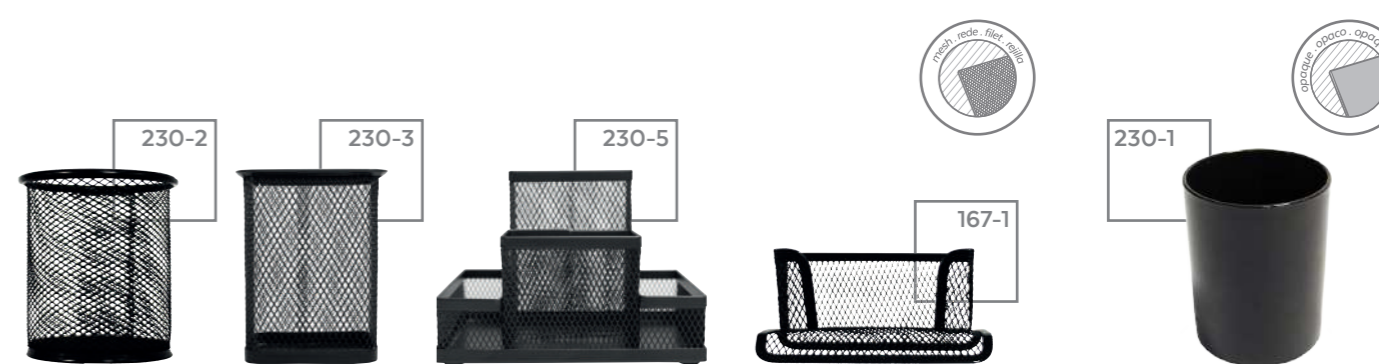

Desk organizers

Metal mesh pieces with many compartments and different formats ideal to organize and maximize desktop space.

Organizadores de secretária

Utensílios metálicos, em rede, vários formatos e compartimentos, ideais para a organização de uma secretária.

Organiseurs de bureau

Pièces en métal mesh avec des compartiments et des différents formats idéals pour organiser et optimiser l'espace de bureau.

Organizadores de oficina

Pièces metálicas con diversos compartimentos y diferentes formatos ideales para organizar y maximizar el espacio del oficina.

ITEM	REF.	mm	Color	12	96
23000402302	230-2	99x88mm	Black	12	96
23000402303	230-3	80x80x99mm	Black	12	96
23000402305	230-5	155x105x100mm	Black	1	96
1670041671	167-1	110x75x50mm	Black	12	24
34400403441	344-1	175x140x82mm	Black	24	96
23000402301	230-1	-	Black	1	-

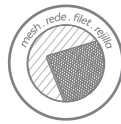

Mesh metal letter tray

Metal mesh tray with drawers and anti-slip pads. For A4 documents.

Tabuleiros secretária

Distribuidores de secretária em rede metálica com gavetas e pés de borracha anti derrapante. Ideais para documentos no formato A4.

Set de corbeilles mesh

Set de corbeilles coulissantes en métal mesh, noir, avec patins anti-glisse. Pour documents jusqu'au format A4.

Bandejas de sobremesa

Conjunto de bandejas de sobremesa en rejilla metálica, extraíbles, con base anti-deslizante. Para documentos en el formato A4.

ITEM	REF.	mm	1	12
0330043302	033-02	350x278x185mm	1	12
0330043303	033-03	350x278x275mm	1	12
0330043304	033-04	350x278x275mm	1	10



Cardboard magazine holder

Corrugated cardboard magazine holder.

Porta-revistas cartão

Suporte para revistas em cartão.

Porte-revues en carton

Porte-revues en carton.

Revisteros en cartón

Soporte para revistas en cartón.

ITEM	REF.	mm	6
025111600	-	L160 300x250x160mm	6

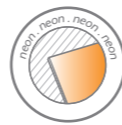

Letter tray

Polystyrene letter vertically stackable or staggered, labelling system.

Tabuleiros secretária

Tabuleiro em poliestireno resistente, empilhável de forma vertical ou escalonada, sistema de etiquetagem.

Corbeille à courrier

Corbeilles à courrier en polystyrène antichoc, superposables et décalables, porte-étiquettes.

Bandeja de plástico

Bandeja de poliestireno resistente, puede apilarse de forma vertical o escalonada, con portaetiquetas.

ITEM	REF.	mm	10
0340020001	-	330x250x58	10
0340020002	-	330x250x58	10
0340020003	-	330x250x58	10
0340020004	-	330x250x58	10
0340020005	-	330x250x58	10
0340020006	-	330x250x58	10
0340020007	-	330x250x58	10
0340020010	-	330x250x58	10
0340020017	-	330x250x58	10
0340020024	-	330x250x58	10
0340020029	-	330x250x58	10
0340020095	-	330x250x58	10
03400488802	-	330x250x58	10
03400488803	-	330x250x58	10

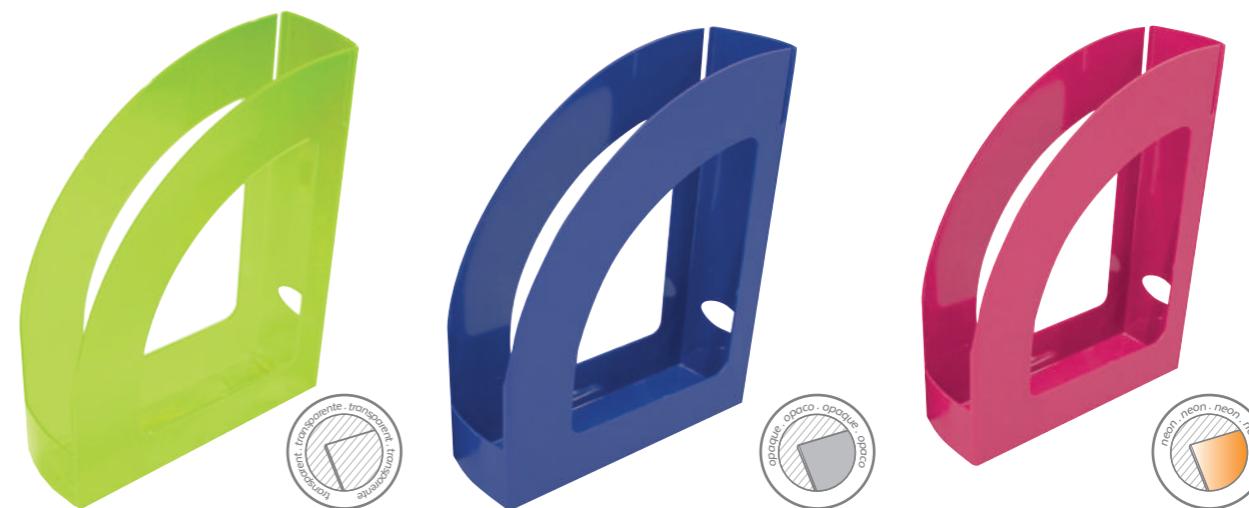

PP magazine holder

Polystyrene magazine holder with a low rear side and finger hole.

Porta-revistas PP

Suporte para revistas em poliestireno transparente ou opaco, com óculo e orifício.

Porte-revues en PP

Porte-revues en polystyrène antichoc, forme co-nique et oeillet de préhension.

Revisteros en PP

Soporte para revistas de poliestireno transparente o opaco, con óculo y orificio.

ITEM	REF.	mm	10
02500420001	200	L80 240x240x85	10
02500420003	200	L80 240x240x85	10
02500420004	200	L80 240x240x85	10
02500420005	200	L80 240x240x85	10
02500420008	200	L80 240x240x85	10
02500420095	200	L80 240x240x85	10
02500420002	200	L80 240x240x85	10
02500420011	200	L80 240x240x85	10
025004200031	200	L80 240x240x85	10
025004200061	200	L80 240x240x85	10
025004200041	200	L80 240x240x85	10

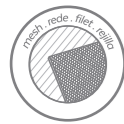

Metallic waste paper bin

Mesh metallic waste paper bin, square, with a capacity of 11 liters.

Cesto papéis metálico

Cesto para papéis metálico, em rede, quadrado, com capacidade para 11 litros.

Corbeille à papier métallique

Corbeille à papier, métallique, en filet, carré, avec une capacité de 11 litres.

Papelera metálica

Papelera metálica, em rejilla, cuadrada, com una capacidat de 11 litres.

ITEM	REF.	218x218x280mm	11L	6
1110040111	111-1	218x218x280mm	11L	6
1110040112	111-2	218x218x280mm	11L	6

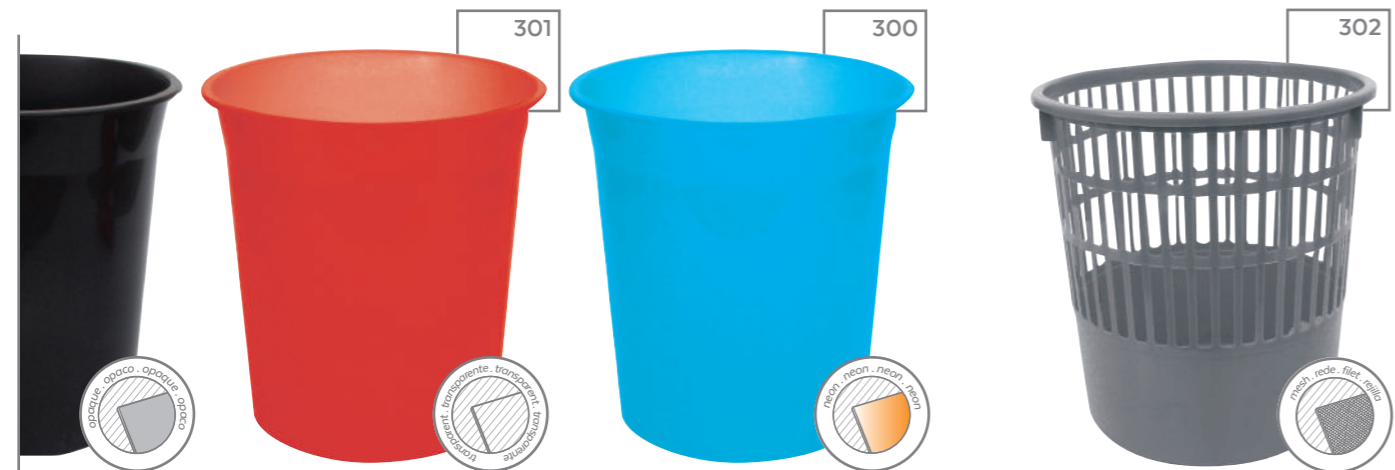

Waste paper bin

Polypropylene waste paper bin, round, with a capacity of 13 liters.

Cesto papéis

Cesto para papéis em polipropileno, redondo, com capacidade para 13 litros.

Corbeille à papier

Corbeille à papier en polypropylène, arrondi, avec une capacité pour 13 litres.

Papelera de plástico

Papelera em polipropileno, ronda, com una capacidat de 13 litres.

ITEM	REF.	320x285mm	13L	20L	10
11100430001	302	320x285mm	13L	20L	10
11100430002	302	320x285mm	13L	20L	10
11100430003	302	320x285mm	13L	20L	10
11100430004	302	320x285mm	13L	20L	10
11100430006	302	320x285mm	13L	20L	10
11100430024	300	320x280mm	13L	20L	10
11100430034	300	320x280mm	13L	20L	10
11100430045	300	320x280mm	13L	20L	10
11100430060	300	320x280mm	13L	20L	10
11100430101	301	320x280mm	13L	20L	10
11100430102	301	320x280mm	13L	20L	10
11100430103	301	320x280mm	13L	20L	10
11100430104	301	320x280mm	13L	20L	10
11100430106	301	320x280mm	13L	20L	10



Desktop calculators

Desktop calculator with 12 and 16 digits, large LCD, large keys and dual power (solar and battery). Features: memory function, percentage calculation, square root button, two zeros key and decimal selectors. Defines roundings and profit margin.

Calculadoras de secretária

Calculadoras com visor de 12 e 16 dígitos, teclas amplas para facilitar a digitalização e duas fontes de alimentação (solar e pilha). Funções: memórias, percentagem, raiz quadrada, tecla de entrada de 2 zeros e selectores de casas decimais. Inclui ainda selector de arredondamentos e a margem de lucro.

Calculatrices de bureau

Calculatrices de bureau avec 12 et 16 chiffres, écran 1 ligne et touches grandes pour taper facilement. Alimentation par solaire et 1 pile. Fonctions: memoires, pourcentage, racine carrée, touches double zero, calcul de taxe, de marge et arrondis.

Calculadoras sobremesa

Calculadora com visor de 12 y 16 dígitos, teclas amplas para facilitar la digitalización, dos fuentes de alimentación (solar y pilas). Funciones: memorias, porcentaje, raíz cuadrada, teclas de entrada de 2 ceros. Incluye selector de redondeos.

ITEM	REF.	12	20	40
0460040046	FL-46	12	20	40
0460040056	FL-56	16	1	40



Scientific calculator

Scientific calculator with dual line display (expression and results can be displayed at the same time). Includes multi-replay functions, fraction and statistic calculations, combinations, permutations, several memories and slide-on protective hand cover. 10 digits, plastic keys and battery power.



Calculadora escolar

Calculadora escolar com visor de 2 linhas (exibe problema e resolução ao mesmo tempo) com matriz de pontos na linha superior, LCD na linha inferior. Inclui várias memórias, função de repetição múltipla, cálculos estatísticos e fracionários, combinações e permutações, e outras funções. 10 dígitos, teclas plásticas e as pilhas como fonte de alimentação.

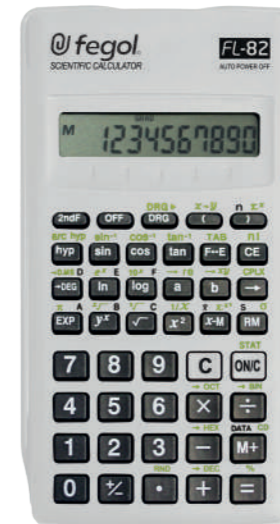

Calculatrice scientifique

Calculatrice scientifique avec écran LCD 2 lignes (l'expression et le résultat sont présentés au même temps). Fonction de répétition multiple, calculs statistiques et fractionnaires, combinaisons, permutations, mémoires et étui de protection. 10 grands chiffres, bouton en plastique et alimentation par pile.

Calculadora escolar

Calculadora escolar com visor de 2 líneas (exhibe problema y solución al mismo tiempo) con matriz de puntos en línea superior, LCD en línea inferior. Incluye varias memorias, función de repetición múltiple, cálculos estadísticos y fraccionarios, combinaciones y otras funciones. 10 dígitos, teclas de plástico y pilas como fuente de alimentación.

ITEM	REF.	10	50	100
0460040082	FL-82	10	50	100

ANNOTATE

ANOTAR

ANNOTER

ANOTAR



01700417538
Expositor de 16 cores
75X75 MM · 100 FL x 16



017004757595
**Notas Aderentes
Transparentes**
75x75 MM · 50 FL



01700417385
Index Pop-Up
12x45 MM · 20 FL x 5



01700417415
Notas Aderentes Multi Smart
1 X 75X75 MM · 3 75X50 MM · 3 X 75X25 MM
1 X 75X115 MM · 45X12 MM · 20FL



01700417477
Index Pop-Up Stick Notes
20FL



01700417446
**Index
numerados**
20 FL x 12



Photocopy paper Go

Natural paper. High whiteness. Produced with 100% pure E.C.F. (without chlorine) cellulose. Acid Free with alkaline to guarantee long permanence - Long Life (ISO 9706). Office top performance.

Papel fotocópia Go

Papel natural. Alta brançura. Produzido com celulose E.C.F. (isento de cloro) 100% pura. Sem ácidos com alcalina, garantindo uma longa duração - Long Life (ISO 9706). Top performance no seu escritório.

Papier pour photocopie Go

Papier naturel. Haute blancheur. Produit avec E.C.F. (sans chlore) 100% pur. Sans acide avec alcaline, assurant une longue durée de vie - Long Life (ISO 9706). Top. Performance bureau.

Papel para fotocópia Go

Papel natural. Alta brançura. Produzido com E.C.F. (sin cloro) 100% puro. Libre de ácido con alcalino, asegurando una larga vida - Long Life (ISO 9706). Top performance em tu oficina.

ITEM	REF.	g/m ²	5	300
2110044800	GO	A4	80	5 300
2110043800	GO	A3	80	5 150



Photocopy paper Smart

Universal quality daily use paper with above-average whiteness and opacity. Effective in photocopying, inkjet and laser printers. Paper for daily use.

Papel fotocópia Smart

Papel de utilização universal de qualidade com brançura e opacidade acima da média. Eficaz em trabalhos de fotocopiadoras, impressoras a jato de tinta e laser. Papel para uso diário.

Papier pour photocopie Smart

Papier de qualité à usage universel avec une blancheur et une opacité supérieures à la moyenne. Efficace dans la photocopie, les imprimantes à jet d'encre et laser. Papier pour un usage quotidien.

Papel para fotocópia Smart

Papel de uso universal de calidad con brançura y opacidad superiores a la media. Eficaz en fotocopiadoras, impressoras inkjet e impressoras láser. Papel de uso diario.

ITEM	REF.	g/m ²	5	300
2110044002	SMART	A4	80	5 300



Notepad

Notepad glued at the top with microperforated white sheets.

Bloc de bureau

Bloc collé en tête, sans perforation, détachables par microperforation.

Bloco apontamentos

Bloco colado no topo, folhas em papel branco, sem furação, microperfuradas.

Bloc de notas

Bloc de hojas encoladas, sin taladros y microperforadas.



Wirebound notepad

Wirebound notepad with microperforated white sheets.

Bloc à spirale

Bloc à spirale, sans perforation, détachables par microperforation.



Bloco apontamentos espiral

Bloco em espiral, folhas em papel branco, sem furação, microperfuradas.

Bloc de notas espiral

Bloc de hojas sin taladros, microperforadas y espiral simple.

ITEM	REF.	g/m ²	5	300	10	40
01500248011	-	A4	60	80	✓	✓
01500248021	-	A4	60	80	✓	✓
01500248031	-	A4	60	80	✓	✓
01500258011	-	A5	60	80	✓	✓
01500258021	-	A5	60	80	✓	✓
01500258031	-	A5	60	80	✓	✓
01500268011	-	A6	60	80	✓	✓
01500268021	-	A6	60	80	✓	✓
01500268031	-	A6	60	80	✓	✓
01500278011	-	A7	60	80	✓	✓
01500278021	-	A7	60	80	✓	✓
01500278031	-	A7	60	80	✓	✓

ITEM	REF.	g/m ²	5	300	10	40
01500248012	-	A4	60	80	✓	✓
01500248022	-	A4	60	80	✓	✓
01500248032	-	A4	60	80	✓	✓
01500258012	-	A5	60	80	✓	✓
01500258022	-	A5	60	80	✓	✓
01500258032	-	A5	60	80	✓	✓
01500268012	-	A6	60	80	✓	✓
01500268022	-	A6	60	80	✓	✓
01500268032	-	A6	60	80	✓	✓
01500278012	-	A7	60	80	✓	✓
01500278022	-	A7	60	80	✓	✓
01500278032	-	A7	60	80	✓	✓

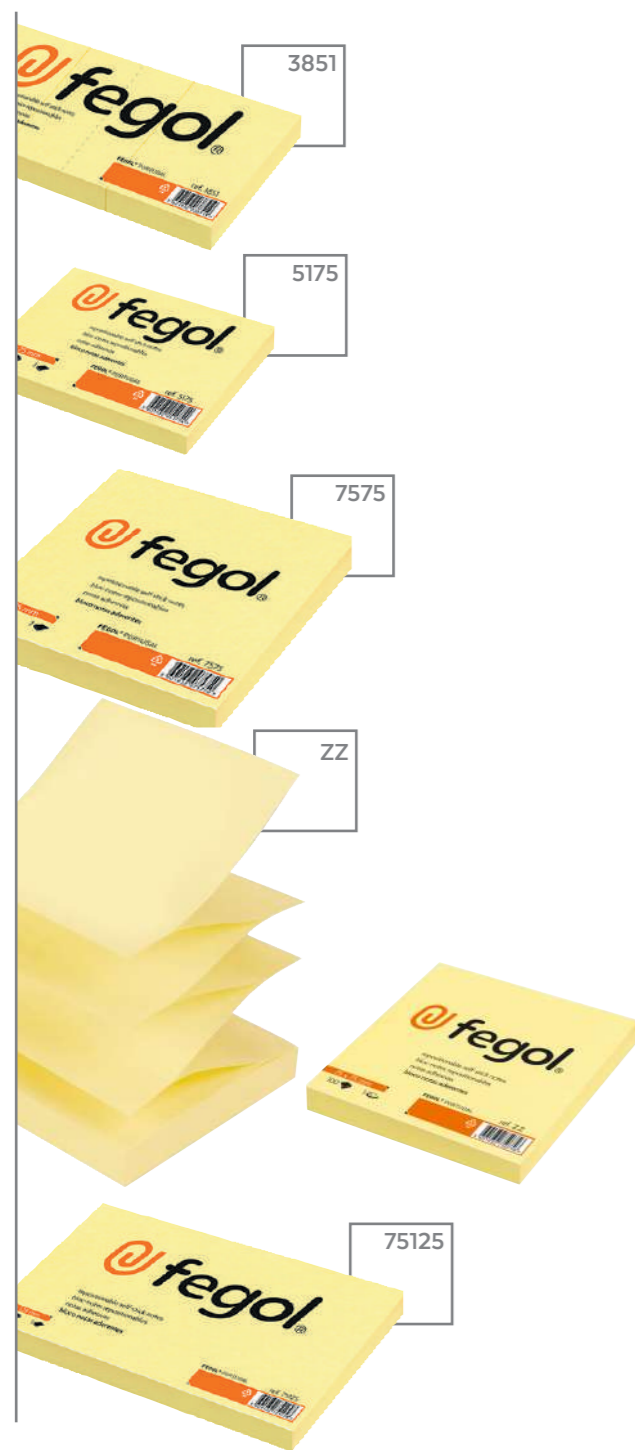

Repositionable yellow notes

Yellow notes with 100 repositionable glued sheets, suitable to any surface.

Notas aderentes

Bloco de 100 folhas com adesivo, colam e descolam em qualquer superfície sem danificar.

Notes jaunes repositionables

Bloc de 100 feuilles adhésives repositionnables sur quelque surface.

Notas adhesivas

Blocs de 100 hojas amarillas con adhesivo en la parte superior se pegan y se despegan de cualquier superficie.

ITEM	REF.	Icon	Icon	Icon	Icon	Icon
0170043851	3851	38x51mm	100	36	864	
0170045175	5175	51x75mm	100	12	432	
0170047575	7575	75x75mm	100	12	384	
01700475075	ZZ	75x75mm	100	12	384	
01700475125	75125	75x125mm	100	12	192	



Pastel Repositionable notes

Box/display with 60 blocks (30-75x75, 15-51x75 and 15-75x125). Sticky notes with 100 sheets in various sizes. Sheets with adhesive on the top, stick and peel, without damaging the surfaces.

Notas aderentes pastel

Expositor com 60 blocos (30-75x75, 15-51x75 e 15-75x125). Notas aderentes com 100 folhas em vários tamanhos. As folhas contém adesivo na parte superior, colam e descolam, sem danificar as superfícies.

Notes repositionables pastel

Boîte avec 60 blocs (30-75x75, 15-51x75 et 15-75x125). Notes adhésives avec 100 feuilles de différentes tailles. Les feuilles ont de l'adhésif sur le dessus, collent et pèlent, sans endommager les surfaces.

Notas adhesivas pastel

Paquete con 60 blocs (30-75x75, 15-51x75 y 15-75x125). Notas autoadhesivas con 100 hojas de varios tamaños. Con adhesivo en la parte superior, se pegan y despegan, sin dañar las superficies.

ITEM	REF.	Icon	Icon	Icon	Icon
0170046099	6099P	100	1	4	



Transparent sticky notes

50 sheet pad with adhesive, which sticks and peels to any surface without damage. Ideal for making quick notes, highlighting information in documents, without losing visibility of the original text or image.

Notas aderentes transparentes

Bloco de 50 folhas com adesivo, colam e descolam em qualquer superfície sem danificar. Ideais para fazer anotações rápidas, destacar informações em documentos, sem perder a visibilidade do texto ou imagem original.

Notes autocollantes transparentes

Bloc de 50 feuilles avec adhésif, qui se colle et se décolle sur n'importe quelle surface sans l'endommager. Idéal pour prendre des notes rapides, mettre en évidence des informations dans des documents, sans perdre la visibilité du texte ou de l'image d'origine.

Notas adhesivas transparentes

Bloc de 50 hojas con adhesivo, que se pega y despegue en cualquier superficie sin dañarla. Ideal para tomar notas rápidas, resaltar información en documentos, sin perder la visibilidad del texto o la imagen original.

ITEM	REF.	Icon	Icon	Icon	Icon
017004757595	-	75x75mm	50	-	-



Repositionable notes cube

Repositionable notes in cubes of 250 or 400 sheets with neon or pastel colors, perfect for taking notes and scheduling appointments.

Cubo notas aderentes

Cubos com 250 ou 400 folhas em cores neon ou pastel com adesivo, reposicionáveis, ideais para apontamento de tarefas, mensagens ou assuntos pendentes.



Cube de notes repositionables

Notes repositionnables en cubes de 250 ou 400 feuilles avec neon et pastel couleurs, idéal pour prendre des notes et des rendez.

Cubo de notas reposicionables

Cubos de 250 y 400 hojas adhesivas reposicionables de colores neon y pastel. Perfecto para tomar notas y programar citas.

ITEM	REF.	Icon	Icon	Icon	Icon	Icon
0170045050	5050	50x50mm	250	12	288	
01700475752	5752	75x75mm	400	6	96	
01700450501	5050P	50x50mm	250	12	288	
01700475753	5752P	75x75mm	400	6	96	



My Sticky Notes

Display with 16 different colours. 5 sticky note pads per colour to suit any need. Ideal for making quick notes and highlighting important information in documents.

Notas aderentes My Sticky Notes

Expositor com 16 cores diferentes. 5 blocos de notas aderentes por cor que se adaptam a qualquer necessidade. Ideais para fazer anotações rápidas e destacar informações importantes em documentos.

Mes notes autocollantes

Présentoir de 16 couleurs différentes. 5 blocs de notes autocollantes par couleur pour répondre à tous les besoins. Idéal pour prendre des notes rapides et souligner les informations importantes dans les documents.

Mis notas adhesivas

Expositor con 16 colores diferentes. 5 blocs de notas adhesivas por color para adaptarse a cualquier necesidad. Ideales para tomar notas rápidas y resaltar información importante en los documentos.

ITEM	REF.	Icon	Icon	Icon	Icon	Icon
01700417538	-	75x75mm	100	-	-	-

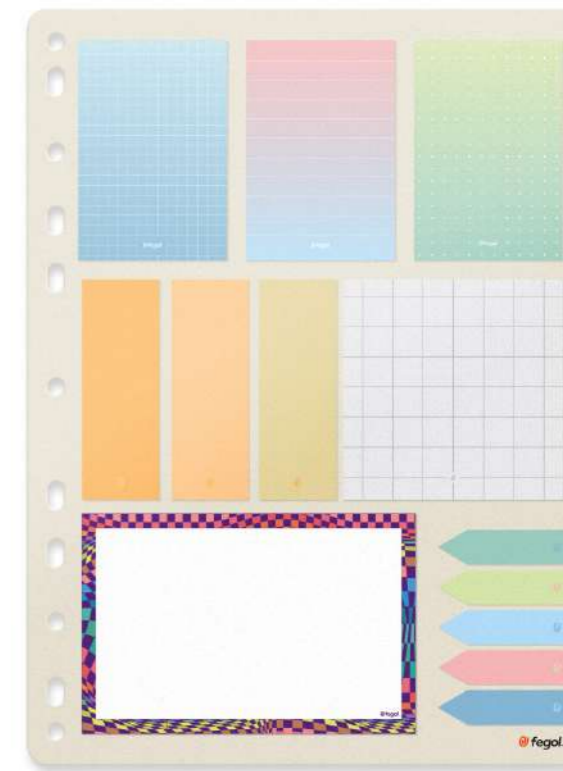

Multi Smart Sticky Notes Set

Recommended for students, teachers and professionals working in office and school environments.

Set Notas Aderentes Multi Smart

Recomendadas para estudantes, professores e profissionais que trabalham em ambiente de escritório e escolar.

Set de notes autocollantes Multi Smart

Recommandé pour les étudiants, les enseignants et les professionnels travaillant dans des bureaux ou des écoles.

Set de notas adhesivas Multi Smart

Recomendado para estudiantes, profesores y profesionales que trabajan en entornos de oficina y escolares.

ITEM	REF.	Icon	Icon	Icon	Icon	Icon
01700417415	-	multi	20	-	-	-

PURE NATURE



Pure Nature repositionable notes cube

Repositionable notes in cubes of 250 or 400 sheets with neon or pastel colors, perfect for taking notes and scheduling appointments.

Cubo notas aderentes Pure Nature

Cubos com 250 ou 400 folhas em cores neon ou pastel com adesivo, reposicionáveis, ideais para apontamento de tarefas, mensagens ou assuntos pendentes.

Cube de notes Pure Nature repositionables

Notes repositionnables en cubes de 250 ou 400 feuilles avec neon et pastel couleurs, idéal pour prendre des notes et des rendez.

Cubo de notas Pure Nature reposicionables

Cubos de 250 y 400 hojas adhesivas reposicionables de colores neon y pastel. Perfecto para tomar notas y programar citas.

ITEM	REF.	50x50mm	250	12	192
01700450502	5050K	50x50mm	250	12	192
01700475754	5752K	75x75mm	400	6	96



Pure Nature repositionable notes

Kraft notes with 100 repositionable glued sheets, suitable to any surface.

Notas aderentes Pure Nature

Bloco de 100 folhas kraft com adesivo, colam e descolam em qualquer superfície sem danificar.

Notes Pure Nature repositionables

Bloc de 100 feuilles kraft adhésives repositionnables sur quelque surface.

Notas adhesivas Pure Nature

Blocs de 100 hojas kraft con adhesivo en la parte superior se pegan y se despegan de cualquier superficie.

ITEM	REF.	51x75mm	100	12	432
017004517510	5175K	51x75mm	100	12	432
017004757510	7575K	75x75mm	100	12	384
0170047512510	75125K	75x125mm	100	12	192

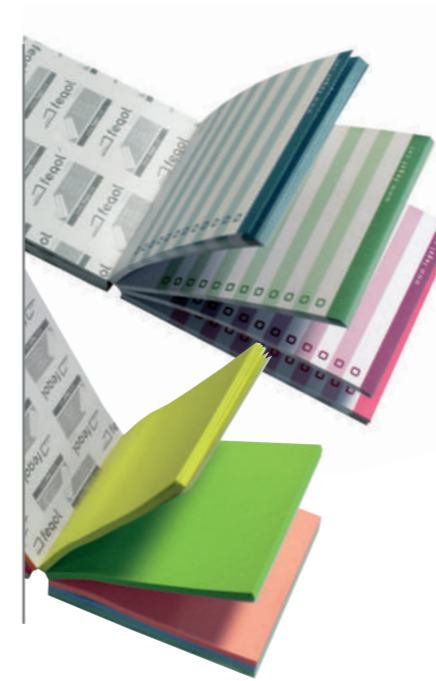

Magic notes cube

Notes cube with 25 sheets, glued on top. Intense colors, easy to detach without damaging the paper. Available in 2 formats: 75x75mm blank sheets and 75x100mm ruled sheets.

Cubo de notas mágico

Cubo de notas com blocos de 25 folhas, colados no topo. As folhas em cores intensas são facilmente destacáveis e contém adesivo na parte superior, colando e descolando sem danificar. Disponíveis em 2 formatos: 75x75mm liso e 75x100mm com linhas impressas para assinalar tarefas a cumprir.

ITEM	REF.	75x100mm	225	6	144
017004751001	75100-M	75x100mm	225	6	144
01700475751	7575-M	75x75mm	200	6	192



Notepad "My task organizer"

Tasks organizer with six 45x45mm and one 100x150mm adhesive cubes. Each cube has a different color and an associated task Today (blue), Contacts (pink), Urgent (salmon), Important (yellow), Buy (green), email (orange). The pastel yellow cube has printed lines to write down your daily tasks. All sheets are adhesive on the top.



Bloco de notas "My task organizer"

Bloco organizador de tarefas com 6 cubos de notas aderentes 45x45mm e 1 bloco aderente 100x150mm. Cada cubo tem uma cor intensa e uma função associada: hoje (azul), contactos (rosa), urgente (salmão), importante (amarelo), comprar (verde), email (laranja). O bloco aderente em amarelo pastel tem impresso várias linhas para a lista de tarefas diárias. Todas as folhas contém adesivo na parte superior. O bloco ideal para a organização diária.



Bloc-notes "My task organizer"

Bloc-notes avec 6 cubos de feuillets adhésives 45x45mm et 1 bloc de 100x150mm. Chaque cube a une couleur vive et une fonction associée: Aujourd'hui (bleu), Contacts (rose), Urgente (saumon), Important (jaune), Acheter (vert), Email (orange). Le bloc jaune pastel a des lignes pour annoter vos tâches. Tous les feuillets sont collés en tête. Le bloc-notes parfait pour votre organisation quotidienne.

Bloco de notas "My task organizer"

Organizador de tarefas com seis cubos adesivos de 45x45mm y uno de 100x150mm. Cada cubo tiene un color diferente y una tarea asociada: Hoy (azul), Contactos (rosa), Urgente (salmón), Importante (amarillo), Comprar (verde), correo electrónico (naranja). El cubo amarillo pastel ha impreso líneas para anotar sus tareas diarias. Cada hoja tien adhesivo en la parte superior.

ITEM	REF.	1 [100x150] + 6 [45x45]mm	6	72
0170040001	1611	1 [100x150] + 6 [45x45]mm	6	72



Pagemakers

Neon colours index pagemakers, perfect to mark and write on.

Índices aderentes

Tiras auto-adesivas, translúcidas coloridas, permitem escrever na superfície.

Marque-pages

Mini-feuillets adhésifs repositionnables, pour être écrit dessus.

Marcador

Tiras autoadesivas, transparentes coloridas, se puede escribir encima.

ITEM	REF.	mm	mm	mm	mm	mm	mm
0170048126	8126	42x12mm	10				60 1440
017004168001	1608-01	25x43mm	50				24 288
017004168003	1608-03	25x43mm	50				24 288
017004168004	1680-04	25x43mm	50				24 288
017004168005	1680-05	25x43mm	50				24 288
017004168008	1680-08	25x43mm	50				24 288
01700417385	POP-UP	45x12mm	20				- -



Pop-UP Stick Notes

Pastel colours index pagemakers, perfect to mark and write on.

Pop-UP Stick Notes

Tiras auto-adesivas, translúcidas em cor pastel, permitem escrever na superfície.

Pop-UP Stick Notes

Mini-feuillets adhésifs repositionnables, pour être écrit dessus.

Pop-UP Stick Notes

Tiras autoadesivas, transparentes coloridas, se puede escribir encima.

ITEM	REF.	mm	mm	mm
01700417477	EXP.	-	-	-
01700417484	MOD.A	-	20	-
01700417491	MOD.B	-	20	-
01700417507	MOD.C	-	20	-



Numbered sticky indexes

Pastel colours index pagemakers, perfect to mark and write on.

Índices aderentes numerados

Tiras auto-adesivas, translúcidas em cor pastel, permitem escrever na superfície.

Index numérotés adhésifs

Mini-feuillets adhésifs repositionnables, pour être écrit dessus.

Índices adherentes numerados

Tiras autoadesivas, transparentes coloridas, se puede escribir encima.

ITEM	REF.	mm	mm
01700417446	45x12mm	20	-



Mini sticky notes

Pack of 100 mini sticky notes with 75 sheets and 6 different shapes. Adhesive on the top, these sheets glue and detach without damaging the surface. Shapes: flower, heart, apple, leaf, balloon, bear, square, mushroom, square balloon and cookie.

Mini-blocos notas aderentes

Pote com 100 mini-blocos de notas aderentes com 75 folhas com 6 formas. As folhas contêm adesivo na parte superior, colam e descolam, sem danificar as superfícies. Formas: flor, coração, maçã, folha, balão, urso, quadrado, cogumelo, balão quadrado e biscoito.

Mini-blocs notes adhésives

Boîte avec 100 mini bloc-notes adhésives avec 75 feuillets et 6 formes divers. Les feuillets collent et détachent sans endommager le papier. Formes: Fleur, cœur, pomme, feuille, ballon, ours, carré, champignon, ballon carré et biscuit.

Mini-blocos notas adhesivas

Paquete con 100 pequeñas notas adhesivas con 75 hojas y 6 formas diferentes. Con adhesivo en la parte superior, se pegan y se separan sin dañar la superficie. Formas: flor, corazón, manzana, hoja, globo, oso, cuadrado, hongo, globo cuadrado y galleta.

ITEM	REF.	mm	mm	mm	mm	mm
01700445451	4545-F	45x45mm	10	1	8	



Book cover film

Self-adhesive, repositionable book cover film, available in three thickness, suitable for wrapping, protecting and laminating.

Película forra livros

Película auto-adesiva, transparente, reposicionável, em 3 espessuras, perfeita para forrar, proteger e plastificar.

Couvre-livres

Film adhésif couvre-livres repositionnable, disponible en 3 épaisseurs, parfait pour couvrir, protéger et plastifier.

Forro adhesivo

Film transparente repositionable con 3 espesuras, perfecto para forrar, proteger y plastificar libros.

ITEM	REF.	mm	mm	mm	mm
13600403315	-	33cmx1,5mt	50	1	25
13600405015	-	50cmx1,5mt	50	1	25
1360040503	-	50cmx3mt	80	1	20
1360045015	-	50cmx15mt	100	1	6
1360045020	-	50cmx20mt	80	1	6

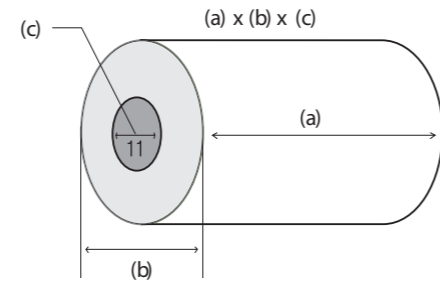

Calculator paper rolls

Extra-white paper rolls with high contrast of black and text resolution.

Rolos papel para calculadora

Papel em rolo extra-branco com elevados contraste de negros e definição de textos.

Papier pour calculatrices

Papier blanc offset en bobine avec haute contraste de noirs et résolution de text.

Rollos papel para calculadora

Papel en rolo extra blanco con elevado contraste de negros y definición de textos.

ITEM	REF.	mm	(a)x(b)x(c)	10	100
1171577011	-	57x70x11	(a)x(b)x(c)	10	100
1171767011	-	76x70x11	(a)x(b)x(c)	10	100
1171576011	-	57x60x11	(a)x(b)x(c)	10	100
1171808011	-	80x80x11	(a)x(b)x(c)	10	100

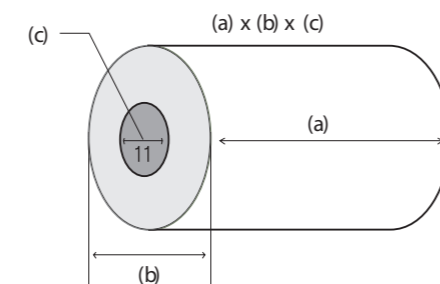

Thermal paper rolls

White paper rolls to be used at hot print machines, such as cash register, balance, cash point, dispenser and others.

Rolos papel térmico

Rolos de papel branco para utilização em máquinas que imprimem a quente, nomeadamente registadoras, balanças, POSs, Multibancos, ATMS, pacómetros, parques de estacionamento e outros.

Papier thermique

Bobine de papier blanc pour utiliser dans les machines qui impriment à chaud, comme caisses enregistreuses, balances, ATM et d'autres. Disponible en multiples mesures.

Rollos papel registradoras

Rollos de papel blanco para registadoras.

ITEM	REF.	mm	(a)x(b)x(c)	10	100
1174805011	-	80x50x11	(a)x(b)x(c)	10	100
1174806011	-	80x60x11	(a)x(b)x(c)	10	100
1174807011	-	80x70x11	(a)x(b)x(c)	10	100
1174808011	-	80x80x11	(a)x(b)x(c)	10	100
1174573011	-	57x30x11	(a)x(b)x(c)	10	100
1174573511	-	57x35x11	(a)x(b)x(c)	10	100
1174574011	-	57x40x11	(a)x(b)x(c)	10	100
1174576011	-	57x60x11	(a)x(b)x(c)	10	100
1174577011	-	57x70x11	(a)x(b)x(c)	10	100
1174574511	-	57x45x11	(a)x(b)x(c)	10	100



Labels A5

Self-adhesive white labels, easy adhesion to any surface.

Etiquetas A5

Etiquetas brancas multiusos com adesivo permanente de elevada aderência.

Etiquettes A5

Etiquettes multiusage blanches, adhérent parfaitement à quelque surface.

Etiquetas A5

Etiquetas brancas multiusos con adhesivo permanente de elevada adherencia.

ITEM	REF.	mm	126	2520	20	90
016004200820	20f10820	8x20mm	126	2520	20	90
016004200913	20f10913	9x13mm	182	3640	20	90
016004201319	20f11319	13x19mm	90	1800	20	90
016004201340	20f11340	13x40mm	45	900	20	90
0160042016	20f116	16mm	96	1920	20	90
016004201622	20f11622	16x22mm	72	1440	20	90
0160042019	20f119	19mm	60	1200	20	90
016004201940	20f11940	19x40mm	35	700	20	90
016004202050	20f12050	20x50mm	24	480	20	90
016004202232	20f12232	22x32mm	36	720	20	90
016004202525	20f12525	25x25mm	35	700	20	90
016004202540	20f12540	25x40mm	25	500	20	90
016004202550	20f12550	25x50mm	20	400	20	90
016004203264	20f13264	32x64mm	12	240	20	90
0160042034100	20f134100	34x100mm	80	160	20	90
016004203467	20f13467	34x67mm	12	240	20	90
016004204165	20f14165	41x65mm	9	180	20	90
0160042050100	20f150100	50x100mm	4	80	20	90
016004205050	20f15050	50x50mm	8	180	20	90

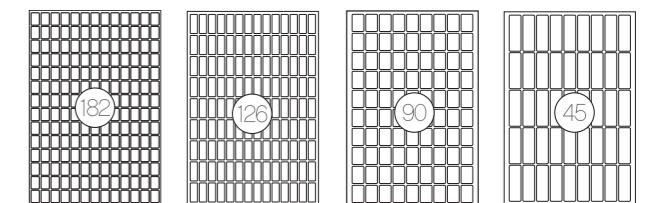

20FL0913 9x13mm, 20FL0820 8x20mm, 20FL1319 13x19mm, 20FL1340 13x40mm

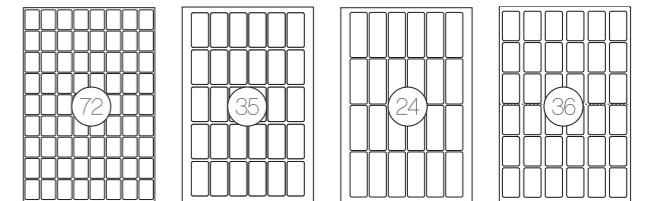

20FL1622 16x22mm, 20FL1940 19x40mm, 20FL2050 20x50mm, 20FL2232 22x32mm

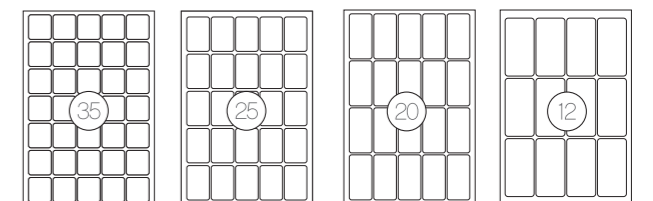

20FL2525 25x25mm, 20FL2540 25x40mm, 20FL2550 25x50mm, 20FL3264 32x64mm

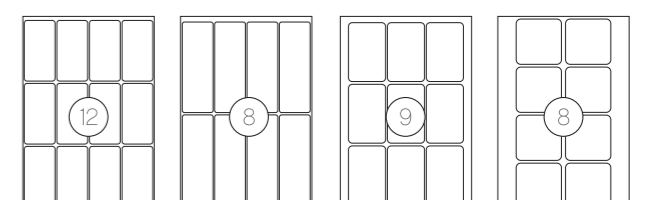

20FL3467 34x67mm, 20FL34100 34x100mm, 20FL4165 41x65mm, 20FL5050 50x50mm

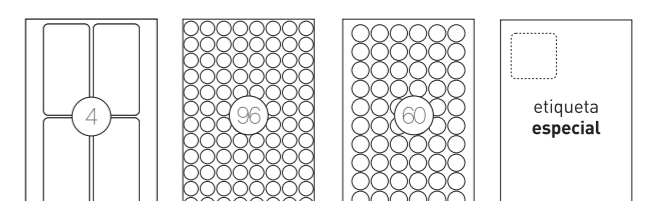

20FL50100 50x100mm, 20FL16 Ø16mm, 20FL19 Ø19mm, sob consulta pergunte-nos



Labels A4

Self-adhesive white labels, easy adhesion to any surface.

Étiquettes A4

Étiquettes multiusage blanches, adhérent parfaitement à quelque surface.

Etiquetas A4

Etiquetas blancas multiusos con adhesivo permanente de elevada adherencia.

Etiquetas A4

Etiquetas blancas multiusos con adhesivo permanente de elevada adherencia.

ITEM	REF.	mm	Grid	Stacks	Rolls	Rolls
0160006734	FL 673400	67x34mm	24	2400	100	14
0160030117	FL CD	117mm	3	300	100	14
0160033011	FL 301100	30x11mm	189	18900	100	14
0160033821	FL 382100	38x21,2mm	65	6500	100	14
0160034825	FL 4825100	48x25,4mm	44	4400	100	14
0160035040	FL 5040100	50x40mm	28	2800	100	14
0160035221	FL 522100	52x21,2mm	56	5600	100	14
0160035225	FL 5225100	52x25mm	48	4800	100	14
0160035229	FL 5219100	52x29,7mm	40	4000	100	14
0160036433	FL 6433100	64,5x33,9mm	24	2400	100	14
0160037024	FL 7024100	70x24mm	36	3600	100	14
0160037025	FL 7025100	70x25,4mm	33	3300	100	14
0160037029	FL 7029100	70x29,7mm	30	3000	100	14
0160037033	FL 7033100	70x33,8mm	24	2400	100	14
0160037037	FL 7037100	70x37,1mm	24	2400	100	14
0160037042	FL 7042100	70x42,4mm	21	2100	100	14
0160037049	FL 7049100	70x49,5mm	18	1800	100	14
0160037070	FL 7070100	70x70mm	12	1200	100	14
0160039742	FL 9742100	97x42,4mm	12	1200	100	14
0160039967	FL 9967100	99x67mm	8	800	100	14
01600310524	FL 10524100	105x25,4mm	22	2200	100	14
01600310535	FL 10535100	105x35mm	16	1600	100	14
01600310537	FL 10537100	105x37mm	16	1600	100	14
01600310542	FL 10542100	105x42,4mm	14	1400	100	14
01600310548	FL 10548100	105x48,5mm	12	1200	100	14
01600310557	FL 10557100	105x57mm	10	1000	100	14
01600310574	FL 10574100	105x74,2mm	8	800	100	14
01600310599	FL 10599100	105x99mm	6	600	100	14
01600319020	FL 19020100	190x20mm	14	1400	100	14
01600319038	FL 19038100	190x38mm	7	700	100	14
01600319058	FL 19058100	190x58mm	5	500	100	14
01600319061	FL 19061100	190x61mm	4	400	100	14
016003105148	FL 105148100	105x148,5mm	4	400	100	14
016003210148	FL 210148100	210x148mm	2	200	100	14
016003210297	FL 210297100	210x297mm	1	100	100	14

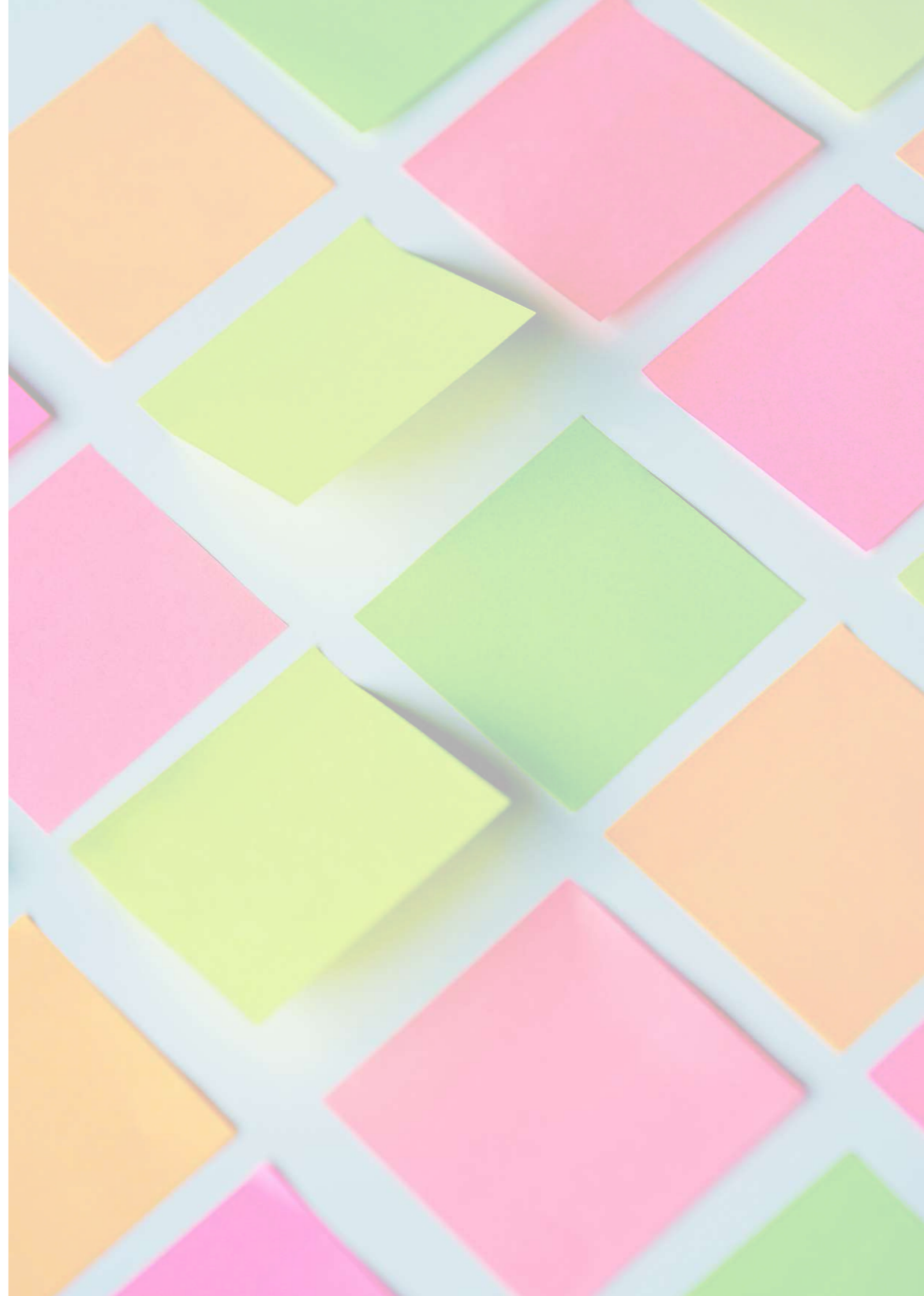
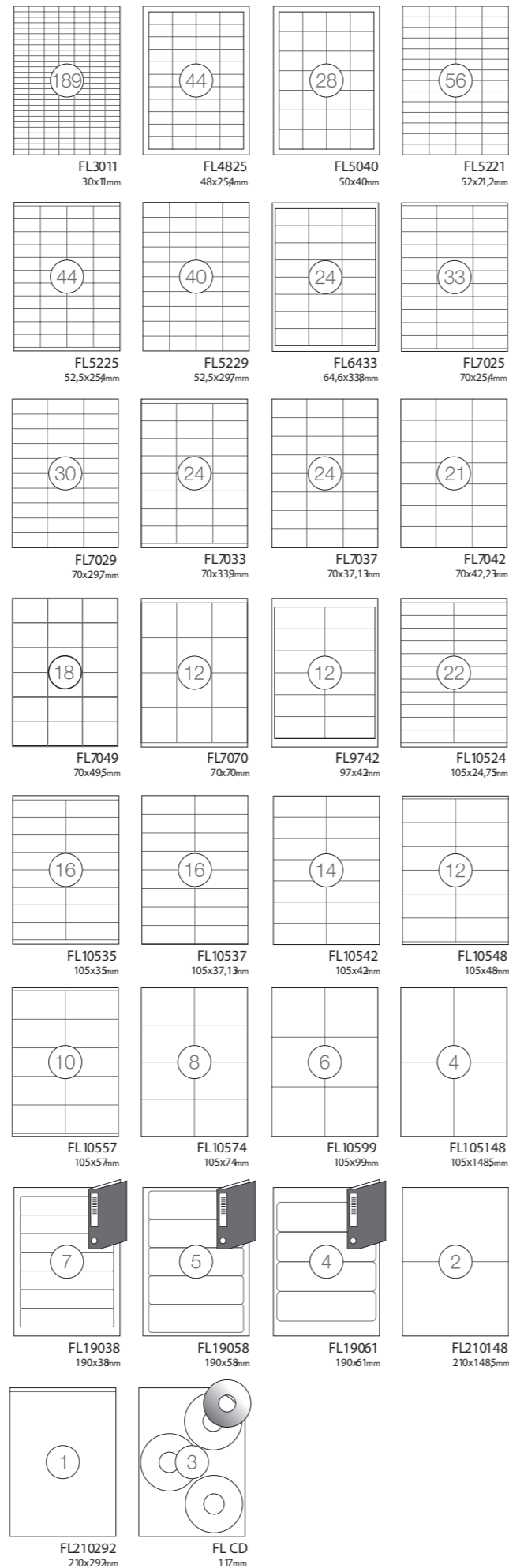

LOGISTICS

LOGÍSTICA

LA LOGISTIQUE

LOGÍSTICA

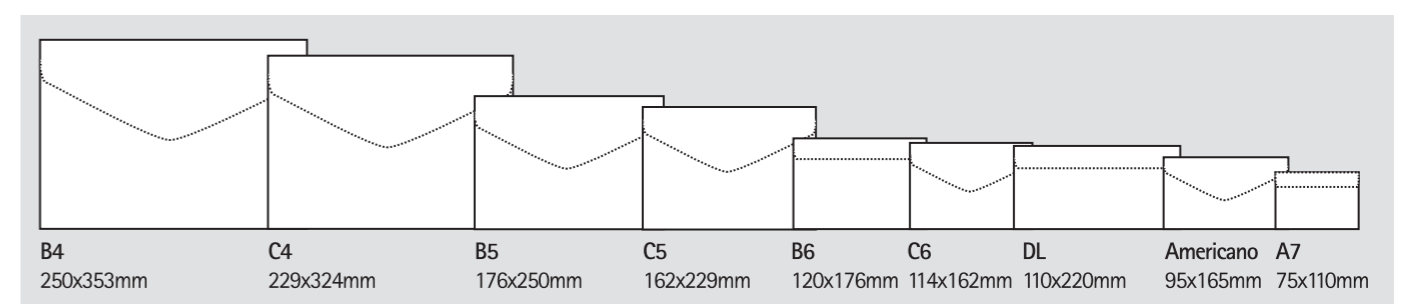

Envelopes

Printed envelopes in plain paper, self seal closure.

Envelopes

Envelopes em papel liso, fundo impresso, autoadesivos.

Enveloppes

Enveloppes imprimé en papier lisse avec gomme.

Sobres

Sobres en papel liso, fondo impresso, autoadhesivos.

ITEM	REF.											
0120010056	56	A7	70	75x110mm	<input type="checkbox"/>	<input checked="" type="checkbox"/>	<input type="checkbox"/>	<input type="checkbox"/>	<input type="checkbox"/>	<input type="checkbox"/>	500	-
0120010006	Nº6	A7	70	75x115mm	<input type="checkbox"/>	<input checked="" type="checkbox"/>	<input type="checkbox"/>	<input type="checkbox"/>	<input type="checkbox"/>	<input type="checkbox"/>	1000	-
0120010031	31L	AMERICANO	70	95x165mm	<input type="checkbox"/>	<input checked="" type="checkbox"/>	<input type="checkbox"/>	<input type="checkbox"/>	<input type="checkbox"/>	<input type="checkbox"/>	500	-
0120040010	-	DL	90	110x220mm	<input type="checkbox"/>	<input checked="" type="checkbox"/>	<input type="checkbox"/>	<input type="checkbox"/>	<input type="checkbox"/>	<input type="checkbox"/>	25	20
012000102202	12102	DL	90	110x220mm	<input type="checkbox"/>	<input checked="" type="checkbox"/>	<input checked="" type="checkbox"/>	<input type="checkbox"/>	<input type="checkbox"/>	<input type="checkbox"/>	500	80
0120040011	-	DL	90	110x220mm	<input type="checkbox"/>	<input checked="" type="checkbox"/>	<input type="checkbox"/>	<input type="checkbox"/>	<input type="checkbox"/>	<input type="checkbox"/>	25	20
012000102201	12101	DL	90	110x220mm	<input type="checkbox"/>	<input checked="" type="checkbox"/>	<input checked="" type="checkbox"/>	<input type="checkbox"/>	<input type="checkbox"/>	<input type="checkbox"/>	500	80
0120040012	-	C6	90	114x162mm	<input type="checkbox"/>	<input checked="" type="checkbox"/>	<input type="checkbox"/>	<input type="checkbox"/>	<input type="checkbox"/>	<input type="checkbox"/>	25	20
0120001141621	12201	C6	90	114x162mm	<input type="checkbox"/>	<input checked="" type="checkbox"/>	<input type="checkbox"/>	<input type="checkbox"/>	<input type="checkbox"/>	<input type="checkbox"/>	500	-
01200412202	12202	C6	90	114x162mm	<input type="checkbox"/>	<input checked="" type="checkbox"/>	<input type="checkbox"/>	<input type="checkbox"/>	<input type="checkbox"/>	<input type="checkbox"/>	500	-
0120007001	70	C6	70	114x162mm	<input type="checkbox"/>	<input checked="" type="checkbox"/>	<input type="checkbox"/>	<input type="checkbox"/>	<input type="checkbox"/>	<input type="checkbox"/>	500	-
0120007011	70	C6	60	114x162mm	<input type="checkbox"/>	<input checked="" type="checkbox"/>	<input type="checkbox"/>	<input type="checkbox"/>	<input type="checkbox"/>	<input type="checkbox"/>	500	-
0120001201765	12501	B6	90	120x176mm	<input type="checkbox"/>	<input checked="" type="checkbox"/>	<input type="checkbox"/>	<input type="checkbox"/>	<input type="checkbox"/>	<input type="checkbox"/>	500	-
0120040001	-	C5	90	162x229mm	<input type="checkbox"/>	<input checked="" type="checkbox"/>	<input type="checkbox"/>	<input type="checkbox"/>	<input type="checkbox"/>	<input type="checkbox"/>	25	20
0120010129	12304	C5	90	162x229mm	<input type="checkbox"/>	<input checked="" type="checkbox"/>	<input type="checkbox"/>	<input type="checkbox"/>	<input type="checkbox"/>	<input type="checkbox"/>	500	-
01200016222980	12305	C5	90	162x229mm	<input type="checkbox"/>	<input checked="" type="checkbox"/>	<input type="checkbox"/>	<input type="checkbox"/>	<input type="checkbox"/>	<input type="checkbox"/>	500	-
0120010310	12303	C5	90	162x229mm	<input type="checkbox"/>	<input checked="" type="checkbox"/>	<input type="checkbox"/>	<input type="checkbox"/>	<input type="checkbox"/>	<input type="checkbox"/>	500	-
0120040002	-	B5	90	176x250mm	<input type="checkbox"/>	<input checked="" type="checkbox"/>	<input type="checkbox"/>	<input type="checkbox"/>	<input type="checkbox"/>	<input type="checkbox"/>	25	20
0120010312	12602	B5	90	176x250mm	<input type="checkbox"/>	<input checked="" type="checkbox"/>	<input type="checkbox"/>	<input type="checkbox"/>	<input type="checkbox"/>	<input type="checkbox"/>	500	-
0120010310	12601	B5	90	176x250mm	<input type="checkbox"/>	<input checked="" type="checkbox"/>	<input type="checkbox"/>	<input type="checkbox"/>	<input type="checkbox"/>	<input type="checkbox"/>	500	-
0120010314	314	C4	90	229x324mm	<input type="checkbox"/>	<input checked="" type="checkbox"/>	<input type="checkbox"/>	<input type="checkbox"/>	<input type="checkbox"/>	<input type="checkbox"/>	250	-
012001804	12401	C4	90	229x324mm	<input type="checkbox"/>	<input checked="" type="checkbox"/>	<input type="checkbox"/>	<input type="checkbox"/>	<input type="checkbox"/>	<input type="checkbox"/>	250	-
0120010137	137	B4	90	250x353mm	<input type="checkbox"/>	<input checked="" type="checkbox"/>	<input type="checkbox"/>	<input type="checkbox"/>	<input type="checkbox"/>	<input type="checkbox"/>	250	-

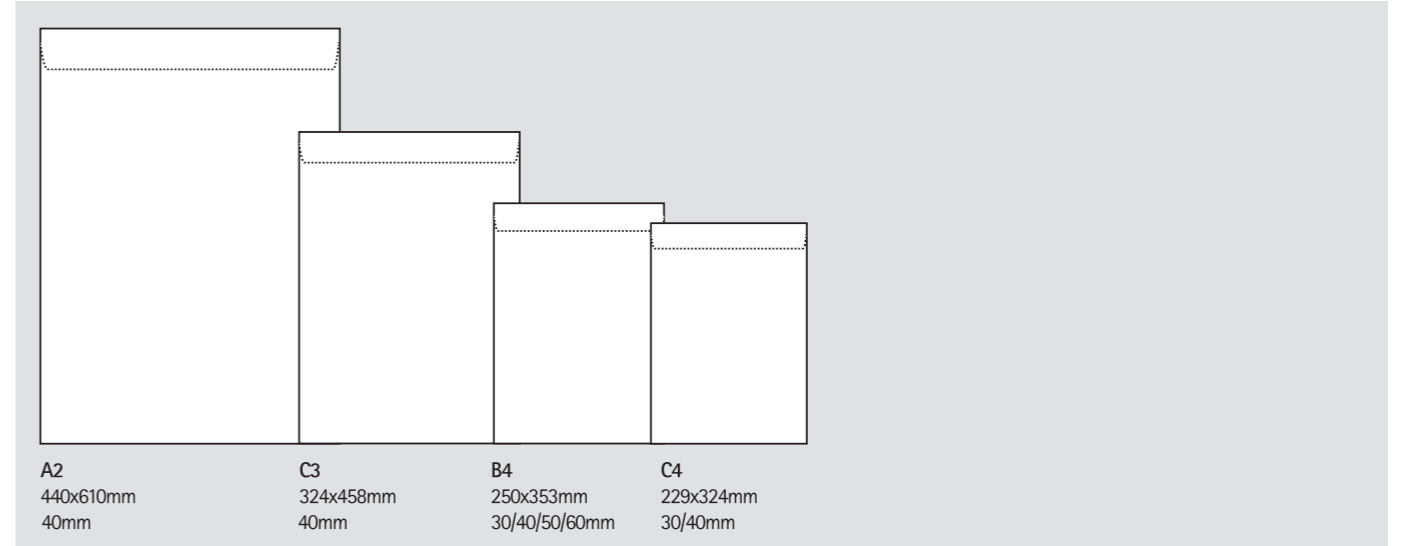
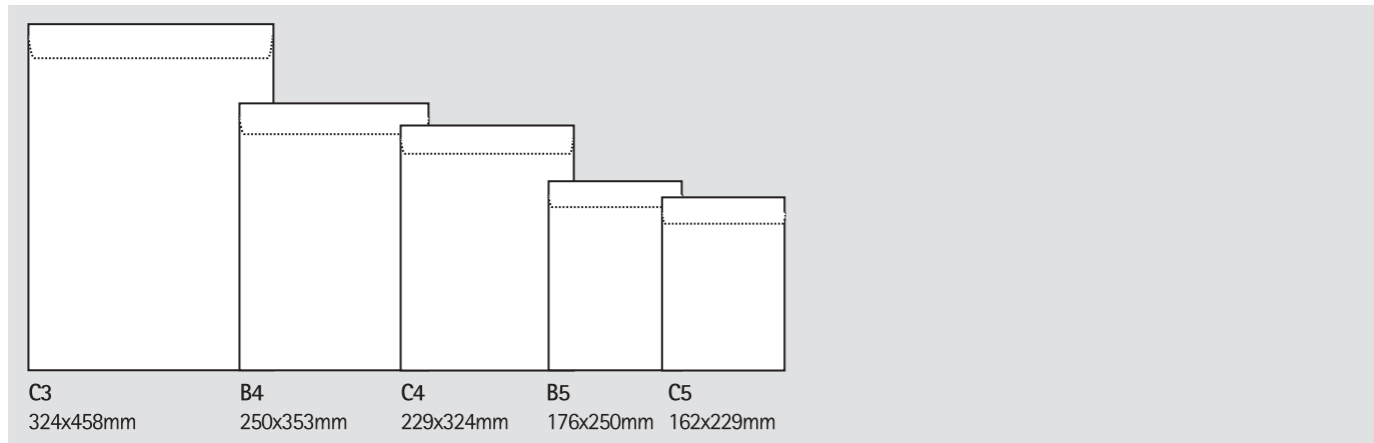

Mailing bags

Printed mailing bags in plain paper, self seal closure.

Saco

Sacos impressos em papel liso, auto-adhesivos.

Pochette

Pochettes imprimé en papier lisse et fermeture siliconée.

Sobres autoadhesivos

Bolsas impresas en papel liso, autoadhesivas.

ITEM	REF.	g/m ²	mm	Icons	25	20
0120040004	-	C5	90	162x229mm	✓	✓
0120040007	-	C5	90	162x229mm	✓	✓
0120011568	12301	C5	90	162x229mm	✓	500
0120011701	12302	C5	90	162x229mm	✓	500
0120011570	12603	B5	90	176x250mm	✓	500
0120011702	12604	B5	90	176x250mm	✓	500
0120011570	12605	B5	90	176x250mm	✓	500
0120040005	-	C4	90	229x324mm	✓	25 10
0120040008	-	C4	90	229x324mm	✓	25 10
0120011576	12402	C4	90	229x324mm	✓	250
0120011704	12403	C4	90	229x324mm	✓	250
0120040006	-	B4	90	250x353mm	✓	25 10
0120040009	-	B4	90	250x353mm	✓	25 10
0120011578	12701	B4	90	250x353mm	✓	250
0120011705	12702	B4	90	250x353mm	✓	250
0120003244582	-	C3	120	324x458mm	✓	125
0120003244585	-	C3	115	324x458mm	✓	250

Gusset bags

Gusset mailing bags with different expansion widths, self seal closure.

Saco com fole

Sacos para expedição auto-adhesivos com fole de várias larguras.

Pochette à soufflets

Pochette à fermeture siliconée de plusieurs largeurs.

Sobres con fuelle

Bolsas autoadhesivas con fuelle de vários milímetros.

ITEM	REF.	g/m ²	mm	OBS.	Icons	250
01200022932432	-	C4	110	229X324MM	30MM	✓
0120002293245	-	C4	90	229X324MM	40MM	✓
01200022932453	-	C4	90	229X324MM	50MM	✓
01200025035333	-	B4	90	250X353MM	30MM	✓
01200025035332	-	B4	110	250X353MM	30MM	✓
012000250353341	-	B4	90	250X353MM	40MM	✓
012000250353344	-	B4	110	250X353MM	40MM	✓
012000250353352	-	B4	110	250X353MM	50MM	✓
012000250353360	-	B4	110	250X353MM	60MM	✓
01200032445842	-	C3	100	324X458MM	40MM	✓
0120004361402	-	A2	110	440X610MM	40MM	✓

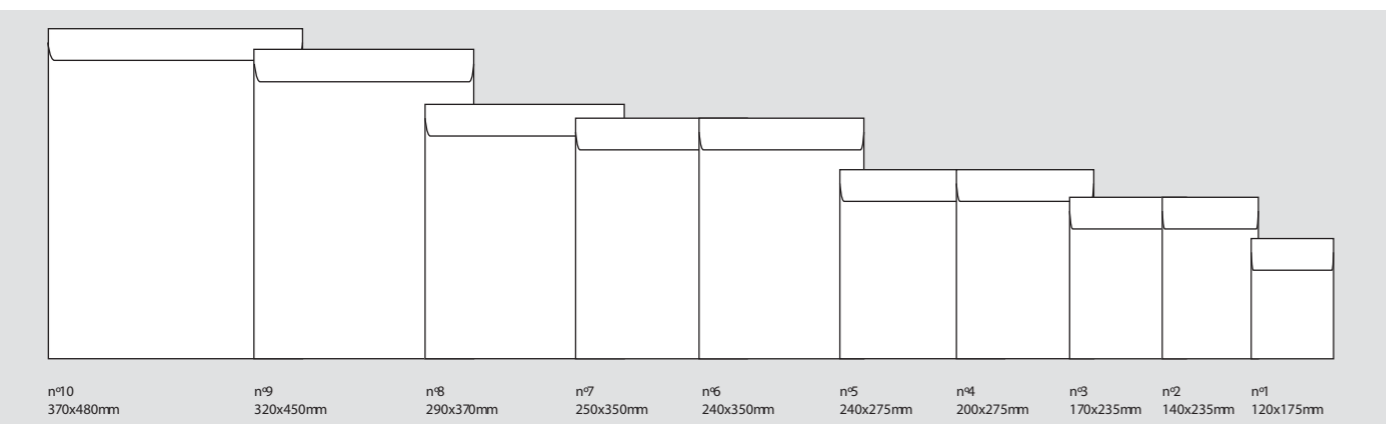
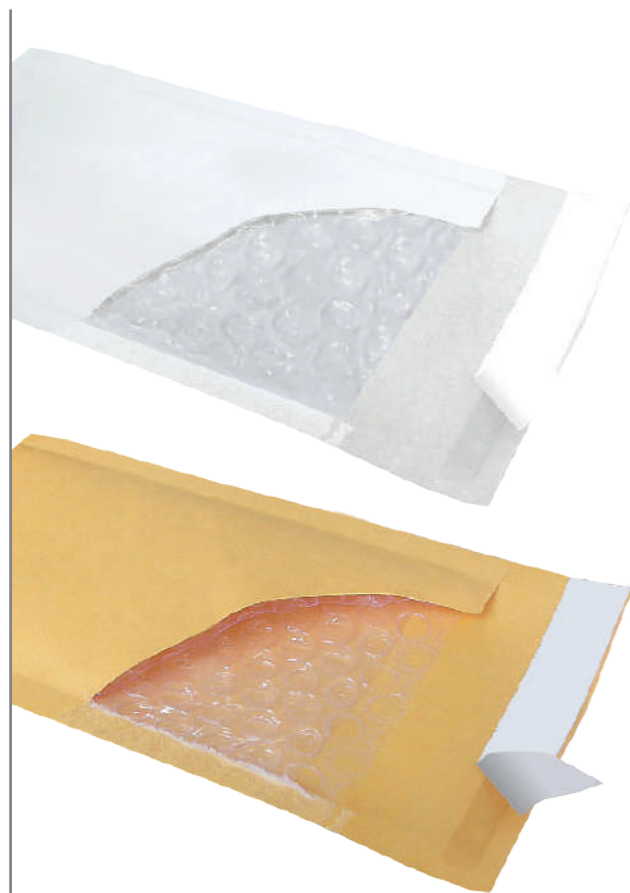

Air bubble bag

Postage air bubble bag with peel and seal enclosure.

Saco almofadado

Saco em papel kraft com interior revestido a bolhas de ar e pala reta com tira adesiva.

Pochette bulle

Pochette bulle avec bande siliconée.

Sobres acolhados

Sobre con burbujas y tira adhesiva.

ITEM	REF.	12mm	15mm	19mm	12mm	15mm	19mm	12mm	15mm	19mm
012000951651	-	N°1	120x175MM	✓	✓	✓	✓	5	5	200
012000211521510	-	N°2	140x235MM	✓	✓	✓	✓	5	5	200
0120003145215	-	N°3	170x235MM	✓	✓	✓	✓	5	5	100
0120004175265	-	N°4	200x275MM	✓	✓	✓	✓	5	5	100
0120005215265	-	N°5	240x275MM	✓	✓	✓	✓	5	5	100
012000240350	-	N°6	240x350MM	✓	✓	✓	✓	5	5	100
0120007235	-	N°7	250x350MM	✓	✓	✓	✓	5	5	100
0120008265360	-	N°8	290x370MM	✓	✓	✓	✓	5	5	100
0120009295445	-	N°9	320x450MM	✓	✓	✓	✓	5	5	50
012000345470	-	N°10	370x480MM	✓	✓	✓	✓	5	5	50
0120000107	-	N°1	120x175MM	✓	✓	✓	✓	5	5	200
012000211521507	-	N°2	140x235MM	✓	✓	✓	✓	5	5	200
012000145215	-	N°3	170x235MM	✓	✓	✓	✓	5	5	100
012000417526507	-	N°4	200x275MM	✓	✓	✓	✓	5	5	100
0120000507	-	N°5	240x275MM	✓	✓	✓	✓	5	5	100
0120000607	-	N°6	240x350MM	✓	✓	✓	✓	5	5	100
0120000707	-	N°7	250x350MM	✓	✓	✓	✓	5	5	100
0120000807	-	N°8	290x370MM	✓	✓	✓	✓	5	5	100
0120000907	-	N°9	320x450MM	✓	✓	✓	✓	5	5	50
0120003454701	-	N°10	370x480MM	✓	✓	✓	✓	5	5	50



Adhesive tape

Transparent adhesive tape, high adherence properties, easy to tear, low noise unwinding.

Fita adesiva

Fitas adesivas transparentes, elevada aderência, desenrolamento fácil, resistente a o envelhecimento.

Ruban adhésif

Ruban adhésif transparent, se découpe et déroule facilement.

Cintas adhesiva

Cinta adhesiva transparente, elevada adherencia, se desenrollan fácilmente.

ITEM	REF.	12mm	15mm	19mm	12mm	15mm	19mm
0110041233	1233	12mmx33mt	accordion	12	1440		
0110041510	1510	15mmx10mt	acordeão	10	1200		
0110041533	1533	15mmx33mt	accordeón	10	600		
0110041933	1933	19mmx33mt	acordeón	8	240		
01100415331	1533IN	15mmx33mt	roll rolo rouleau rollo	1	24		
011004153324	1533IN	15mmx33mt	pot expositor pot expositor	1	24		
01100421233	1233-BLT2	12mmx33mt		1	20		
01100421533	1533-BLT2	15mmx33mt	blister	1	20		
01100421933	1933-BLT2	19mmx33mt		1	15		



Invisible adhesive tape

Transparent adhesive tape, invisible, can be written on.

Fita adesiva invisível

Fita adesiva mate, invisível quando aplicada, pode escrever-se por cima.

Ruban adhésif invisible

Ruban mat au fini, invisible, permet l'écriture.

Cinta adhesiva invisible

Cinta adhesiva mate, invisible, se puede escribir.

ITEM	REF.	19mmx33mt	10	480
0110043319	3319	19mmx33mt	10	480



Tape dispenser

Polypropylene tape dispenser for 33 meters adhesive tapes, non-slip rubber base, nickel plated zig zag blade.

Desenrolador de secretária

Desenrolador em polipropileno resistente, base anti-derrapante, lâmina de corte em zig zag.

Dévidoir de bureau

Dévidoir de bureau en polypropylene avec base antidérapante et lame zig zag métallique.

Portarrollos

Portarrollos para cinta de 33 metros fabricado en polipropileno resistente, base antiderrapante y lámina de corte en zig-zag.

ITEM	REF.	15mm x33mts	1	40
0640040350	350	15mm x33mts	1	40



1510
DISP



1510D-
BLT2



15mm



Adhesive tape with dispenser

Transparent mini adhesive tape with a dispenser.

Fita adesiva com desenrolador

Mini-rollos de fita adesiva com desenrolador de plástico transparente.

Ruban adhésif avec dévidoir

Mini-rouleaux de ruban adhésif avec un dévidoir transparent.

Cinta adhesiva con portarollo

Mini-rollos con portarollos en plástico transparente.

ITEM	REF.	mm	OBS.	rollo + expositor	rouleaux + dévidoir	rollo + expositor	32	12
01100415101	1510DISP	15mmx10mt	roll + dispenser	rollo + expositor	rouleaux + dévidoir	rollo + expositor	32	12
011004151032	1510DISP	15mmx10mt	pot	expositor	pot	expositor	32	12
01100499910	1510D-BLT2	15mmx10mt	1 dispenser roll + 2 rolls	1 desenrolador com fita + 2 rolos	1 dévidoir + 2 rouleaux	1 expositor con rollo + 2 rolos	1	8



Tape hand dispenser

Box sealing tape dispenser easy to operate with an ergonomic handle.

Dérouleur manuel

Facile de manipuler avec une poignée ergonomique pour une utilisation intensive.

Desenrolador de fita embalagem

Desenrolador fácil de manusear com pega ergonómica para uso intensivo.

Dispensador de cinta

Dispensador muy cómodo de utilizar, con caucho antideslizante y ergonómico.



Packaging tape

PP Packaging tape, silent and unwinding.

Ruban d'emballage

PP rubans adhésif, avec un déroulement sans bruit et un excellent pouvoir adhésif.

ITEM	REF.	mm	6	36
01100401110	01195	50mmx66mt	6	36
01100401195	01110	50mmx66mt	6	36

Fita de embalagem

Fita adesiva em polipropileno, elevada adesividade, desenrolamento uniforme e silencioso.

Cinta de embalaje

Cinta adhesiva en polipropileno, elevada adhesividad, se desenrolla de forma uniforme y silenciosa.

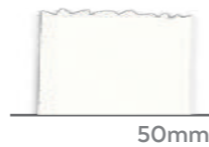

50mm



Project tubes

Expedition tubes to hold projects in rigid card, closed in both ends.

Tubes pour projects

Tubes en carton rigide fermé aux 2 extrémités avec couvercles plastiques blanches.

Porta desenhos

Tubo porta desenhos em cartão com tampas plásticas brancas em ambas as extremidades.

Tubo portadocumentos

Porta documentos en tubo de cartón con tapas de plástico blancas en ambas extremidades.

ITEM	REF.	mm	1	20
3180040330	-	d/50mm	330mm	1
3180040550	-	d/50mm	550mm	1
31800470800	-	d/70mm	800mm	1
3180041000	-	d/75mm	1100mm	1



Corrugated cardboard

Corrugated cardboard, flexible and resistant, ensures safety of contents.

Carton ondulé

Carton ondulé, flexible et résistant, protègent parfaitement les produits.



Cartão micro canelado

Cartão ondulado, flexível e resistente à perfuração. Uma solução económica para várias utilizações.

Rollo cartón microcanelado

Cartón ondulado, flexible y resistente a la perforación. Una solución económica para una protección reforzada des artículos.

ITEM	REF.	mm	1	29
05200450507	-	50cmx5mt	1	29
05200450510	-	50cmx5mt	1	35



Air bubble roll

Ideal for all postage and packaging needs. Flexible, waterproof, light.

Rouleau de bulles

Film que protège les envois divers de tous les chocs. Souple, imperméable et léger.

Borbulhas

Material de embalagem leve e flexível para a proteção de produtos frágeis.

Rollo de burbujas

Material de embalaje flexible para la protección de productos frágiles. Contiene pequeñas burbujas de aire que protegen el producto de choques y de caídas.

ITEM	REF.	mm	1
3320041005	1005	1x5mt	1
3320040550	0550	0,5x50mt	1
3320041050	1050	1x50mt	1



Clipboard

PP clipboard with sturdy and nickel-plated clip at top.

Porte-blocs

Porte-blocs en polypropilene rigide, clip et crochet de suspension de metal.

ITEM	REF.	mm	1	48
14500414552	14552	340x225mm	1	48

Prancheta

Prancheta em plástico translúcido com mola tipo clip no topo.

Carpeta miniclip

Carpeta miniclip de PP con pinza de metal.

PRESENTATION

APRESENTAÇÃO

PRÉSENTATION

PRESENTACIÓN



Magnetic whiteboard

Magnetic whiteboards with dry-erase surface, aluminium frame and versatil tray.

Quadro branco magnético

Quadro com superfície magnética branca, caixilho metálico e bandeja.

Tableau blanc

Tableau blanc, surface magnétique, cadre en aluminium et repose-stylo.

Pizarra blanca magnética

Pizarra blanca magnética, marco de aluminio e bandeja porta-útiles.

ITEM	REF.		OBS.	
00600460901	-	60x90cm		1
006004901201	-	90x120cm	ceramic	1
0060041201501	-	120x150cm	cerâmico	1
0060041201802	-	120x180cm	cerâmique	1
0060041202001	-	120x200cm	cerámica	1
0060041202501	-	120x250cm		1
00600426090	006-2-6090	60x90cm		1
006004290120	006-2-90120	90x120cm	enamel	1
0060042120150	006-2-120150	120x150cm	porcelana	1
0060042120180	006-2-120180	120x180cm	porcelaine	1
0060042120200	006-2-120200	120x200cm	porcelana	1
0060042120250	006-2-120250	120x250cm		1



Refillable whiteboard marker WB100

Refillable whiteboard marker with alcohol-based and odorless ink. Propylene body and round tip. Quick drying and easy to erase. Up to 800m writing length. 2-3mm line.

Marcador quadro branco WB100 recarregável

Marcador para quadro branco com tinta à base de álcool e secagem rápida, recarregável, ponta redonda e corpo em polipropileno. Apagável em seco e baixo odor. Escreve 800 metros. Traço de 2-3mm.

Marqueur pour tableau blanc rechargeable WB100

Marqueur tableau blanc rechargeable d'encre à base d'alcool et sans odeur. Corps en propylène et pointe ronde. Séchage rapide et facile à effacer. Jusqu'à 800m d'écriture. Ligne de 2-3 mm.

Rotulador recargable de pizarra blanca WB100

Rotulador recargable de pizarra blanca con tinta a base de alcohol y inodora. Cuerpo en propileno y punta redonda. Se seca rápido y se borra fácilmente. Escribe hasta 800 metros. Trazo de 2-3 mm.

ITEM	REF.	+/-	Tip	Box	Box	Box
150004010001	WB100	2-3mm	Blue	✓	10	120
150004010002	WB100	2-3mm	Black	✓	10	120
150004010003	WB100	2-3mm	Red	✓	10	120
150004010004	WB100	2-3mm	Green	✓	10	120
15000400100	WB100-99	2-3mm	2x Blue, 2x Black, 1x Red, 1x Green, 1x Orange, 1x Purple, 1x Pink	✓	12	72



Whiteboard eraser Triline

Fegol Triline is a premium magnetic eraser, ideal for whiteboards, with a smart and functional design. It includes a replaceable refill and an integrated compartment that holds up to three markers.

Apagador para quadro branco Triline

O Fegol Triline é um apagador magnético premium, ideal para quadros brancos, com um design inteligente e funcional. Inclui recarga substituível e um compartimento integrado que acomoda até três marcadores.

Whiteboard marker Triline

Its ergonomic triangular shape provides firm and controlled writing, with quick-drying, low-odor ink that is efficient for everyday use.

Marcador para quadro branco Triline

A sua forma triangular ergonómica proporciona uma escrita firme e controlada, com tinta de secagem rápida e baixo odor, eficiente no uso diário.

Marqueur pour tableau blanc Triline

Sa forme triangulaire ergonomique permet une écriture ferme et contrôlée, avec une encre à séchage rapide et peu odorante, efficace au quotidien.

Rotulador pizarra blanca Triline

Su forma triangular ergonómica proporciona una escritura firme y controlada, con tinta de secado rápido y bajo olor, eficaz en el uso diario.

ITEM	REF.	Tip	Box	Box	Box
1500043001	TRILINE-01	Blue	✓	12	720
1500043002	TRILINE-02	Black	✓	12	720
1500043003	TRILINE-03	Red	✓	12	720
1500043004	TRILINE-04	Green	✓	12	720

ITEM	REF.	Tip	Box	Box	Box
1520043300	Triline-33	Triline Plus	12	720	✓
1520043000	Triline-30		12	720	



Whiteboard marker refill WB100R

Whiteboard marker refill. With marker's tip pointing up, spin the nib and replace it. Do not change until it is completely dry.

Recarga para marcador quadro branco WB100R

Recarga de tinta para marcador de quadro branco WB100 com 6 grs. Deve ser colocada com o marcador na vertical (ponta para cima), rodar e substituir. Não deve ser removido com tinta.

Recharge pour marqueur de tableau blanc WB100R

Recharge pour marqueur de tableau blanc. Avec la pointe pointant vers le haut, tourner la pointe d'écriture et le remplacer. Ne changez pas jusqu'à ce qu'il soit complètement sec.

Recarga para rotulador de pizarra blanca WB100R

Recarga para rotulador de pizarra blanca. Con la punta del marcador apuntando arriba, girar la punta y reemplazarla. No cambiar hasta que esté completamente seca.

ITEM	REF.	Tip	Box	Box	Box
003004010001	WB100R	Blue	✓	24	288
003004010002	WB100R	Black	✓	24	288
003004010003	WB100R	Red	✓	24	288
003004010004	WB100R	Green	✓	24	288



Whiteboard marker WB90

Whiteboard marker with ink that can be easily erased with a sponge or a tissue, polypropylene white barrel and ventilated cap.



Marcador para quadro branco WB90

Marcador com tinta à base de álcool, apagável a seco, corpo em PP, tampa ventilada e hermética.

Marqueur pour tableau blanc WB90

Marqueur pour tableau blanc avec corp en polypropylène, encre à base d'alcool, sans odeur, effaçable à sec.

Rotulador pizarra blanca WB90

Marcador de tinta a base de alcohol, con cuerpo en polipropileno, capuchon ventilado y hermético.

ITEM	REF.	Tip	Box	Box	Box
1500049001	WB90	Blue	✓	24	1200
1500049002	WB90	Black	✓	24	1200
1500049003	WB90	Red	✓	24	1200
1500049004	WB90	Green	✓	24	1200
1500040090	WB90-BLT4-1	1x Blue, 1x Black, 1x Red, 1x Green	✓	48	288
15000400901	WB90-BLT4-2	4x Black	✓	48	288
15000400902	WB90-BLT4-3	4x Blue	✓	48	288
15000400903	WB90-BLT4-4	2x Blue, 2x Black	✓	48	288
15000400904	WB90-BLT4-5	4x Red	✓	48	288



Triline whiteboard eraser recharges

The Fegol Triline eraser refill ensures efficient and practical cleaning of whiteboards, extending the eraser's useful life.

Recargas apagador quadro branco Triline

A recarga para apagador Fegol Triline garante uma limpeza eficiente e prática dos quadros brancos, prolongando a vida útil do apagador.

Recharge pour effaceur Fegol Triline magnétique Triline

La recharge pour effaceur Fegol Triline garantit un nettoyage efficace et pratique des tableaux blancs, prolongeant ainsi la durée de vie de l'effaceur.

Recargas para borrador pizarra blanca Triline

El recambio para borrador Fegol Triline garantiza una limpieza eficaz y práctica de las pizarras blancas, prolongando la vida útil del borrador.

ITEM	REF.	Box
1520043900	TRILINE-39	100





Chalkboard eraser

Chalkboard eraser with felt sponge and wood handle.

Apagador quadro lousanite

Apagador para quadros de ardósia com ponta de feltro e pega em madeira.

Effaceur pour tableau à craies

Effaceur pour tableau à craies avec pointe en feutre et poignée en bois.

Borrador pizarra de tiza

Borrador de fieltro para pizarra de tiza con mango de madeira.

ITEM	REF.		
1520040731	731	6	240



Magnets

Round magnetic buttons in assorted colors with a diameter of 30mm.

Magnetos

Botões magnéticos redondos, de cores sortidas com diâmetro de 30mm.

Magnets

Boutons magnétiques ronds de couleurs assorties avec un diamètre de 30mm.

Imanes

Botones magnéticos redondos en colores sortidos con un diámetro de 30mm.

ITEM	REF.					
1470041476	147-6	30mm			12	288



Drawing Pins

Short brass pin with plastic spherical head, used to fasten documents to a wall or a board.

Pionéses

Pionaisas cravadas em latão com cabeça redonda forrada em plástico colorido.

Punaises

Punaises avec tête ronde recouverte de plastique coloré.

Chinchetas

Chincheta en latón con cabeza redonda forrada en plástico de colores.

ITEM	REF.			
08700408707	087-07		100	12
08700408799	087-99		100	12



Pins

Metallic tack with a large plastic head (round head or push pin).

Alfinetes

Alfinetes metálicos com cobertura em plástico colorido (redondos ou cabeça alta).

Épingles

Épingles avec pointe métallique et tête en plastique de couleur.

Chinchetas señalizadoras

Punzón metálico con cabeza de plástico de colores (en forma redonda o alfiler) indicados para la señalización y organización.

ITEM	REF.			
08100408199	081-99		75	12

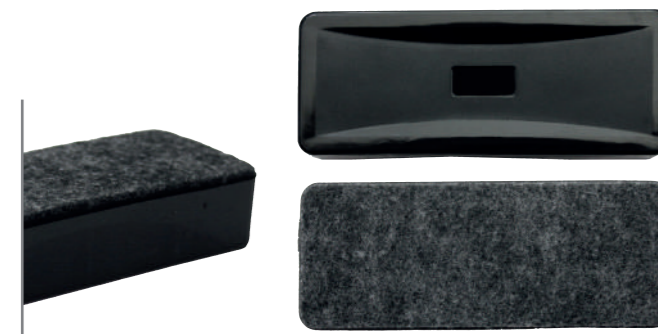

Whiteboard eraser

Dry erasable board, light weight, plastic cable, magnetic.

Apagador para quadro branco

Apagador a seco ultra leve com cabo de plástico, magnético.

Effaceur pour tableau blanc

Effaceur pour effacement à sec, ultra-léger avec câble en plastique et magnétique.

Borrador pizarra blanca magnético

Borrador en seco ultra suave con cabo de plástico, magnético.

ITEM	REF.		
1520040783	783	90	360

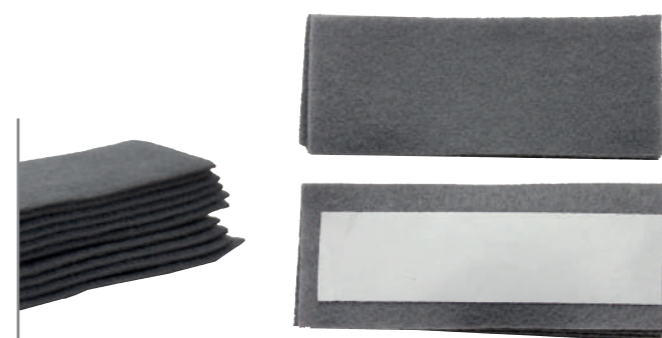

Whiteboard eraser eraser recharges

Fegol eraser recharges for magnetic whiteboards.

Recargas apagador quadro branco

Recargas para os apagadores da Fegol realiza a limpeza a seco dos quadros brancos magnéticos.

Recharge pour effaceur magnétique

Recharges pour les effaceurs magnétiques Fegol. Efface à sec les tableaux.

Recargas para borrador pizarra blanca

Recargas para os borradores da Fegol hace la limpieza en seco del pizarras blancas magnéticos.

ITEM	REF.		
15200407831	7831	10	160



Cleaning

The perfect solution to remove dirt and give whiteboards anti-static properties. (May use other sprays or wipes, depending on the dirt).

Limpeza

A solução perfeita para eliminar a sujidade e tornar o quadro branco limpo e com propriedades anti-estáticas. (Poderá ser limpo por vários sprays ou toalhetes, dependendo do grau de sujidade).

Nettoyage

La solution parfaite pour enlever la saleté et donner au tableau blanc des propriétés anti-statiques. (Peut être nettoyé par plusieurs sprays ou lingettes, selon le niveau de saleté).

Limpeiza

La solución perfecta para eliminar la suciedad y hacer que la pizarra limpia y propiedades antiestáticas. (Puede ser limpiado por varios aerosoles o toallitas, dependiendo del grado de suciedad).

ITEM	REF.	OBS.				
22700402272	227-2	wipes toalhetes toalhetes toalhetes	-	100	1	10



Corkboard

Corkboard with aluminium frame and adjustable pen tray.

Quadro em cortice

Quadro com superfície em cortiça, caixilho metálico e bandeja.

Tableau en liège

Tableau en liège, cadre en aluminium et repose-stylo.

Pizarra de corcho

Pizarra de corcho con marco de aluminium y bandeja porta-útiles.

ITEM	REF.		
00600440601	-	40x60cm	1
00600460902	-	60x90cm	1
006004901202	-	90x120cm	1
0060041001502	-	100x150cm	1
0060041201502	-	120x150cm	1
0060041202002	-	120x200cm	1
0060041202401	-	120x240cm	1

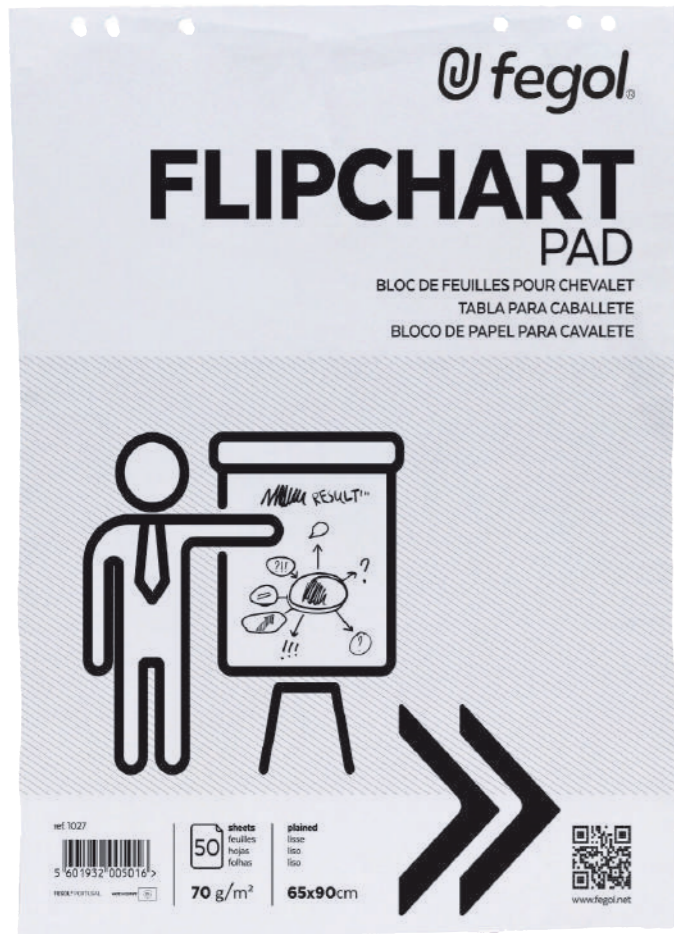

Meeting chart pad

Pad with plain white sheets, 6 holes, pre-perforated.

Bloco para flipchart

Bloco com folhas brancas, 6 furos, microperfuradas.

ITEM	REF.	65x90cm	50	✓	5
0050011027	1027	65x90cm	50	✓	5
0050001027	-	65x90cm	25	✓	10



Tableau mural

Bloc avec feuilles blanches, 6 trous, prédecoupées détachables.

Bloc conferencias

Bloc con hojas blancas, 6 agujeros, microperforadas.

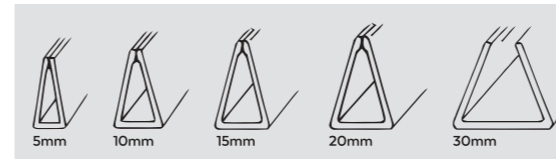
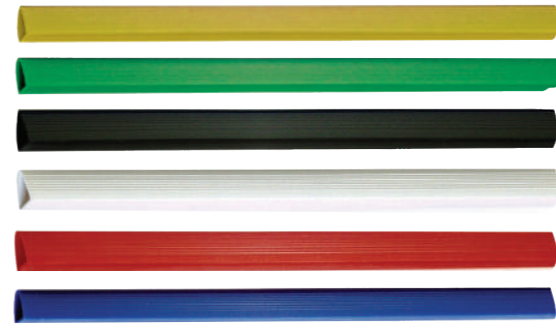

Slide binders

Triangle plastic spine bars quick and simple to use, ideal to bind unpunched papers.

Baguetes triangulares

Baguete triangular de encadernação em plástico para documentos não perfurados. De fácil colocação devido às pontas aperfeiçoadas.

Baguettes à relier

Baguettes à relier triangulaires en plastic simple d'utiliser. Ces baguettes servent à relier les documents avec ou sans couverture.

Varilla encuadernadora

Varilla triangular de plástico para encuadernación de documentos no perforados. De fácil colocación.

ITEM	REF.	A4	5mm	50	100	1
1580000501	-	A4	5mm	50	100	1
1580000502	-	A4	5mm	50	100	1
1580000503	-	A4	5mm	50	100	1
1580000504	-	A4	5mm	50	100	1
1580000505	-	A4	5mm	50	100	1
1580000506	-	A4	5mm	50	100	1
1580000507	-	A4	5mm	50	100	1
1580000595	-	A4	5mm	50	100	1
1580001001	-	A4	10mm	100	100	1
1580001002	-	A4	10mm	100	100	1
1580001003	-	A4	10mm	100	100	1
1580001004	-	A4	10mm	100	100	1
1580001005	-	A4	10mm	100	100	1
1580001006	-	A4	10mm	100	100	1
1580001007	-	A4	10mm	100	100	1
1580001095	-	A4	10mm	100	100	1
1580001501	-	A4	15mm	150	100	1
1580001502	-	A4	15mm	150	100	1
1580001503	-	A4	15mm	150	100	1
1580001504	-	A4	15mm	150	100	1
1580001505	-	A4	15mm	150	100	1
1580001506	-	A4	15mm	150	100	1
1580001507	-	A4	15mm	150	100	1
15800015095	-	A4	15mm	150	100	1
1580002001	-	A4	20mm	200	100	1
1580002002	-	A4	20mm	200	100	1
1580002003	-	A4	20mm	200	100	1
1580002004	-	A4	20mm	200	100	1
1580002005	-	A4	20mm	200	100	1
1580002006	-	A4	20mm	200	100	1
1580002007	-	A4	20mm	200	100	1
15800020095	-	A4	20mm	200	100	1
1580003001	-	A4	30mm	250	100	1
1580003002	-	A4	30mm	250	100	1
1580003003	-	A4	30mm	250	100	1
1580003004	-	A4	30mm	250	100	1
1580003005	-	A4	30mm	250	100	1
1580003006	-	A4	30mm	250	100	1
1580003007	-	A4	30mm	250	100	1

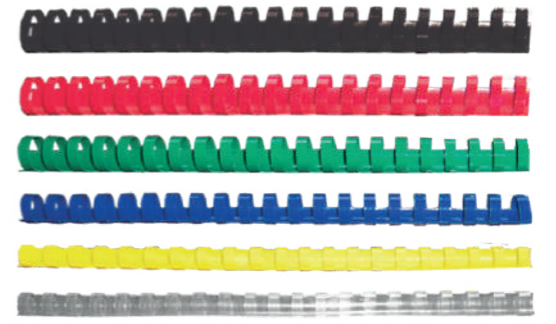

Plastic binding combs

Plastic combs round or oval from 6 to 52 mm.

Argolas plásticas espiral

Argolas em plástico redondas ou em oval desde 6 a 52 mm.

Peignes plastiques

Peignes plastiques en forme ronde et oval de 6 a 52 mm.

Canutillos de plástico

Canutillos de plástico redondos o en forma oval desde 6 a 52 mm.

ITEM	REF.	A4	6mm	30	100	1	20
1530000601	-	A4	6mm	30	100	1	20
1530000602	-	A4	6mm	30	100	1	20
1530000603	-	A4	6mm	30	100	1	20
1530000604	-	A4	6mm	30	100	1	20
1530000605	-	A4	6mm	30	100	1	20
1530000606	-	A4	6mm	30	100	1	20
1530000607	-	A4	6mm	30	100	1	20
15300006095	-	A4	6mm	30	100	1	20
1530000801	-	A4	8mm	50	100	1	20
1530000802	-	A4	8mm	50	100	1	20
1530000803	-	A4	8mm	50	100	1	20
1530000804	-	A4	8mm	50	100	1	20
1530000805	-	A4	8mm	50	100	1	20
1530000806	-	A4	8mm	50	100	1	20
1530000807	-	A4	8mm	50	100	1	20
15300008095	-	A4	8mm	50	100	1	20
1530001001	-	A4	10mm	70	100	1	20
1530001002	-	A4	10mm	70	100	1	20
1530001003	-	A4	10mm	70	100	1	20
1530001004	-	A4	10mm	70	100	1	20
1530001005	-	A4	10mm	70	100	1	20
1530001006	-	A4	10mm	70	100	1	20
1530001007	-	A4	10mm	70	100	1	20
15300010095	-	A4	10mm	70	100	1	20
1530001201	-	A4	12mm	90	100	1	10
1530001202	-	A4	12mm	90	100	1	10
1530001203	-	A4	12mm	90	100	1	10
1530001204	-	A4	12mm	90	100	1	10
1530001205	-	A4	12mm	90	100	1	10
1530001206	-	A4	12mm	90	100	1	10
1530001207	-	A4	12mm	90	100	1	10
15300012095	-	A4	12mm	90	100	1	10
1530001401	-	A4	14mm	110	100	1	10
1530001402	-	A4	14mm	110	100	1	10
1530001403	-	A4	14mm	110	100	1	10
1530001404	-	A4	14mm	110	100	1	10
1530001405	-	A4	14mm	110	100	1	10
1530001406	-	A4	14mm	110	100	1	10
1530001407	-	A4	14mm	110	100	1	10
15300014095	-	A4	14mm	110	100	1	10
1530001601	-	A4	16mm	130	100	1	10
1530001602	-	A4	16mm	130	100	1	10
1530001603	-	A4	16mm	130	100	1	10
1530001604	-	A4	16mm	130	100	1	10
1530001605	-	A4	16mm	130	100	1	10
1530001606	-	A4	16mm	130	100	1	10
1530001607	-	A4	16mm	130	100	1	10
15300016095	-	A4	16mm	130	100	1	10
1530001901	-	A4	19mm	170	100	1	-
1530001902	-	A4	19mm	170	100	1	-
1530001903	-	A4	19mm	170	100	1	-
1530001904	-	A4	19mm	170	100	1	-
1530001905	-	A4	19mm	170	100	1	-
1530001906	-	A4	19mm	170	100	1	-
1530001907	-	A4	19mm	170	100	1	-
15300019095	-	A4	19mm	170	100	1	-
1530002201	-	A4	22mm	190	50	1	-
1530002202	-	A4	22mm	190	50	1	-
1530002203	-	A4	22mm	190	50	1	-
1530002204	-	A4	22mm	190	50	1	-
1530002205	-	A4	22mm	190	50	1	-
1530002206	-	A4	22mm	190	50	1	-
1530002207	-	A4	22mm	190	50	1	-
15300022095	-	A4	22mm	190	50	1	-
1530002501	-	A4	25mm	220	50	1	-
1530002502	-	A4	25mm	220	50	1	-
1530002503	-	A4	25mm	220	50	1	-
1530002504	-	A4	25mm	220	50	1	-
1530002505	-	A4	25mm	220	50	1	-
1530002506	-	A4	25mm	220	50	1	-
1530002507	-	A4	25mm	220	50	1	-
1530002595	-	A4	25mm	220	50	1	-
1530003202	-	A4	32mm	240	50	1	-
1530003207	-	A4	32mm	240	50	1	-
1530003802	-	A4	38mm	260	50	1	-
1530003807	-	A4	38mm	260	50	1	-



Metal binding combs

Metal wire binding combs with a 5.1 slot pitch and a distance of 2mm per hole.

Argolas espiral metálicas

Argolas metálicas em espiral com passo de furação 5.1 e um intervalo de 2 em 2 mm.

Spirale métallique de reliure

Reliure anneaux métallique avec un espacement des fentes 5.1 et un intervalle de 2mm.

Canutillo de alambre

Canutillo de alambre com un paso de ranura 5.1 y un intervalo de 2mm.

ITEM	REF.								
153004510607	-	A4	6mm	20		100	1		
153004510602	-	A4	6mm	20		100	1		
153004510616	-	A4	6mm	20		100	1		
153004510807	-	A4	8mm	40		100	1		
153004510802	-	A4	8mm	40		100	1		
153004510816	-	A4	8mm	40		100	1		
153004511007	-	A4	10mm	60		100	1		
153004511002	-	A4	10mm	60		100	1		
153004511016	-	A4	10mm	60		100	1		
153004511207	-	A4	12mm	80		100	1		
153004511202	-	A4	12mm	80		100	1		
153004511216	-	A4	12mm	80		100	1		
153004511407	-	A4	14mm	100		100	1		
153004511402	-	A4	14mm	100		100	1		
153004511416	-	A4	14mm	100		100	1		
153004511607	-	A4	16mm	120		100	1		
153004511602	-	A4	16mm	120		100	1		
153004511616	-	A4	16mm	120		100	1		
153004512007	-	A4	20mm	160		100	1		
153004512002	-	A4	20mm	160		100	1		
153004512016	-	A4	20mm	160		100	1		



Binding covers

Semi-rigid transparent cover made from polypropylene with 150 or 180 microns. Anti-glare finish.

Acetatos encadernação

Folha para encadernação em polipropileno com 150 ou 180 microns. Protege as suas apresentações.

Couvertures pour reliures

Couvertures transparentes en polypropylène pour baguettes à relier. Format A4 et avec 150 ou 180 microns.

Portadas de encuadernación

Folha para encadernação em polipropileno com 150 ou 180 microns. Protege as suas apresentações.

ITEM	REF.				OBS.		
15700049595	9595	A4	150			100	1000
157000418095	18095	A4	180		translucido	100	1000
15700415701	15701	A4	180		translúcido	100	1000
15700415702	15702	A4	180		translúcido	100	1000
15700415703	15703	A4	180		translúcido	100	1000
15700415704	15704	A4	180			100	1000
15700415705	15705	A4	180			100	1000
15700415706	15706	A4	180		opaque	100	1000
15700415707	15707	A4	180		opaco	100	1000
15700415708	15708	A4	180		opaque	100	1000
15700415709	15709	A4	180		opaco	100	1000
15700415710	15710	A4	180		opaco	100	1000
15700415711	15711	A4	180			100	1000



PRODUCTS CATALOGUE

CATÁLOGO DE PRODUCTOS

CATALOGUE DES PRODUITS

CATÁLOGO DE PRODUCTOS



sales@fegol.net

www.fegol.net

+351 309 700 190

